

**ALL SPORT® 5500 SERIES
CONTROL CONSOLE**

OPERATION MANUAL

P1389

ED-16809
Rev 11
03 January 2023

FCC Statement

Supplier Declaration of Conformity (SDoC)

This product complies with Part 15 of the FCC Rules. Operation is subject to the following two conditions: (1) This device may not cause harmful interference, and (2) this device must accept any interference received, including interference that may cause undesired operation.

Note: This equipment has been tested and found to comply with the limits for a Class A digital device, pursuant to part 15 of the FCC Rules. These limits are designed to provide reasonable protection against harmful interference when the equipment is operated in a commercial environment. This equipment generates, uses, and can radiate radio frequency energy and, if not installed and used in accordance with the instruction manual, may cause harmful interference to radio communications. Operation of this equipment in a residential area is likely to cause harmful interference in which case the user will be required to correct the interference at their own expense.

Warning: The user is cautioned that changes and modifications made to the equipment without the approval of manufacturer could void the user's authority to operate this equipment.

Industry Canada Regulatory Information

This Class A digital apparatus complies with Canadian ICES-003.

Cet appareil numérique de la classe A est conforme à la norme NMB-003 du Canada.

Inquiries

Contact Daktronics with any questions regarding our product compliance.

Mail:

Daktronics
201 Daktronics Dr.
Brookings, SD 57006 USA

Phone:

800-325-8766

Website:

www.daktronics.com



DAKTRONICS

Copyright © 2006-2023

All rights reserved. While every precaution has been taken in the preparation of this manual, the publisher assumes no responsibility for errors or omissions. No part of this book covered by the copyrights hereon may be reproduced or copied in any form or by any means—graphic, electronic, or mechanical, including photocopying, taping, or information storage and retrieval systems—without written permission of the publisher.

Daktronics trademarks are property of Daktronics, Inc. All other trademarks are property of their respective companies.

Table of Contents

1 Introduction	1	General Multi-Purpose Timer	18
Important Safeguards	1	Standard Keys	18
Specifications Label	2	Segment Timer	18
Resources	2	Team Name Entry	19
Console Revision History.....	2	WIDTH	19
Daktronics Exchange and Repair & Return Programs	2	HEIGHT	19
Exchange Program	2	FONT	19
Repair & Return Program	3	3 Segment Timer Operation	20
Daktronics Warranty & Limitation of Liability.....	3	Segment Timer Overview.....	20
2 Basic Operation	4	Accessing Segment Timer	20
Console Operation.....	4	Accessing 2-Digit or 6-Digit Display Segment Timer	21
Sport Inserts.....	5	Segment Timer Keys	21
Start Up	6	Segment Number & Time	21
Standard Keys	6	First Segment	21
Start	6	Last Segment	22
Stop	6	Interval Time	22
Enter/Yes	6	Display Interval	22
Clear/No.....	7	Copy Range	22
Edit	7	Auto Stop	23
Menu	7	Reset to First	23
Set Main Clock	7	Reset Current Segment	23
Count Up/Down	8	Current Segment	23
Auto Horn	9	Edit.....	23
Manual Horn	9	Current Segment	23
Remote Start/Stop Controls.....	9	Menu	23
Main Clock Control.....	9	New Code	24
Shot Clock Control	9	Warning Time	24
Setting Radio Channels	10	Dimming Menu	24
Single Controller System	11	Default Settings	24
Multiple Controller System with Single Broadcast Group	12	4 Basketball Operation	25
Multiple Controller with Multiple Broadcast Groups.....	13	Basketball Keys.....	25
Menu	14	Set Shot Time	25
New Game.....	14	Recall Shot Time	26
New Code	15	Time Out On/Off	26
Dimming Menu	15	Blank Player Foul	26
Display Menu	15	Period +1	27
Color Menu	16	Time Out	27
Time of Day	17	Score (+1/+2/+3/-1)	27
Switch Output.....	18	Team Fouls (+1/-1)	28
		Bonus	29
		Possession	29

Table of Contents

In Game/Out of Game	29	In Game/Out of Game	43
Delete Player.....	29	Delete Player.....	43
Player.....	29	Player.....	43
Individual Substitution	30	Individual Substitution	44
Mass Substitution	31	Mass Substitution	45
Edit.....	31	Edit.....	45
Time Out	31	Time Out	45
Score (+1/+2/+3/-1).....	32	Score (+1/-1).....	46
Team Fouls (+1/-1)	32	Match Number +1, Sets +1	46
Period +1	32	Sets Won +1, Subs +1	46
Time Out On/Off.....	32	Aces +1, Kills +1, Blocks +1, Digs +1 ...	46
Menu	33	Time Out On/Off.....	46
New Game.....	33	Menu	47
New Code	33	New Game.....	47
Dimming Menu	33	New Code	47
Home Roster, Guest Roster	33	Dimming Menu	47
Display Menu	34	Home Roster, Guest Roster	47
Color Menu	34	Display Menu	49
Time of Day	34	Color Menu	49
Edit Settings	35	Time of Day	49
Number of Periods.....	35	Edit Settings	49
Main Clock.....	35	Main Clock.....	49
Shot Clock.....	36	Time Outs.....	49
Time Outs.....	36	Team Stats	50
Team Score	37	User Def 1 & User Def 2	50
Team Fouls	37	Select Captions	51
Select Captions	38	Shot Horn Control.....	51
Select Team Foul Display.....	38	Light Control	51
Score by Quarter	38	Switch Output.....	51
Shot Horn Control.....	38	Default Settings	52
Light Control	39	6 Wrestling Operation.....	53
Switch Output.....	39	Wrestling Keys.....	53
Default Settings	39	Match Number +1	53
5 Volleyball Operation	40	Period +1	53
Volleyball Keys	40	Set Main Clock (Period Times)	54
Time Out On/Off.....	40	Home Advantage, Guest Advantage, Stop Advantage Clock.....	54
Time Out	41	Team Score (+1/-1)	55
Match Number +1, Sets +1	41	Match Score (+1/+2/+3/-1).....	55
Score (+1/-1).....	41	Start/Stop Injury Time	55
Sets Won +1, Subs +1	42	Reset Match	56
Aces +1, Kills +1, Blocks +1, Digs +1 ...	42	Start/Stop Blood Time	56
Serve	42		

Table of Contents

Start/Stop Recovery Time	57
Edit.....	57
Home Advantage.....	57
Guest Advantage.....	57
Blood Time.....	58
Injury Time	58
Match Number, Period, Team Score, Match Score.....	58
Menu	58
New Game.....	58
New Code	58
Dimming Menu	59
Home Roster, Guest Roster	59
Weight Class	60
Display Menu	60
Color Menu	60
Time of Day	60
Edit Settings	60
Main Clock.....	60
Blood/Injury Time.....	61
Recovery Time	61
Select Captions	62
Weight Class	62
Display Lines for Weight Class.....	62
Display Team Score.....	62
Shot Horn Control.....	62
Light Control.....	63
Switch Output.....	63
Default Settings	63
A Reference Drawings	65
B Sport Inserts	77
C Sport Code Numbers.....	85
D Quick Reference.....	87
All Sport 5500 Standard Keys.....	87
Segment Timer	88
Basketball	89
Volleyball.....	90
Wrestling	91
E Supplementary Documents.....	93
F Daktronics Warranty and Limitation of Liability.....	99

This page intentionally left blank.

1 Introduction

This manual explains the operation of All Sport® 5500 series control consoles. For additional information regarding the safety, installation, operation, or service of this system, refer to the telephone numbers listed in **Daktronics Exchange and Repair & Return Programs (p. 2)**.

Important Safeguards

- **Read and understand all instructions, both general and for specific sports.**
- **Always turn off and/or unplug the control equipment when it is not in use. Never yank the power cord to pull the plug from the outlet. Grasp the plug and pull to disconnect.**
- **Do not drop the control console or allow it to get wet.**
- **This device shall not be exposed to dripping or splashing, and no objects filled with liquid shall be placed upon it.**

WARNING! To reduce the risk of fire or electric shock, do not expose this device to rain or moisture.

- **Console may include internal battery backup, or external battery pack.**

CAUTION! DANGER OF EXPLOSION IF BATTERY IS INCORRECTLY REPLACED. REPLACE ONLY WITH THE SAME OR EQUIVALENT TYPE.

WARNING! Do not expose batteries to excessive heat, such as direct sunlight or fire.

- **Do not let the power cord touch hot surfaces or hang over the edge of a table that would damage or cut the cord.**
- **If an extension cord is necessary, use a three-pronged, polarized cord. Arrange the cord with care so that it will not be tripped over or pulled out.**
- **Before using an extension cord, inspect the cable thoroughly and verify its compliance with the local electric codes.**
- **Do not disassemble control equipment or electronic controls of the display; failure to follow this safeguard will make the warranty null and void.**
- **Inspect console for shipping damage such as rattles and dents, and verify that all equipment is included as itemized on the packing slip. Immediately report any problems to Daktronics; save all packing materials if exchange is necessary.**

All Sport consoles receive external power through a standard 8' (2.44 m) long three-pronged power cord plugged into a 120 VAC grounded outlet. The outlet shall be installed near the console and easily accessible. Contact Daktronics for information on running an All Sport console via optional battery power pack.

Note: The console features an internal time delay 1/8 amp, 250 V fuse. In the unlikely event the fuse needs to be replaced, contact Daktronics Customer Service.

Specifications Label

Power specifications as well as product assembly information can be found on the rear of the console. When calling Daktronics customer service, please have the assembly number and the date manufactured available to ensure the request is serviced as quickly as possible.

Resources

Figure 1 illustrates a Daktronics drawing label. This manual refers to drawings by listing the last set of digits. In the example, the drawing would be referred to as **DWG-1007804**. All references to drawing numbers, appendices, figures, or other manuals are presented in bold typeface. Any drawings referenced in a particular section are listed at the beginning of it as shown below:

		DAKTRONICS, INC. BROOKINGS, SD 57006		THE CONCEPTS EXPRESSED AND DETAILS SHOWN ON THIS DRAWING ARE CONFIDENTIAL AND PROPRIETARY. DO NOT REPRODUCE BY ANY MEANS WITHOUT THE EXPRESSED WRITTEN CONSENT OF DAKTRONICS, INC. COPYRIGHT 2010 DAKTRONICS, INC.	
DO NOT SCALE DRAWING					
PROJ: DAKTRONICS					
TITLE: SYSTEM RISER DIAGRAM					
DESIGN:			DRAWN: APAGE		DATE: 11 MAY 10
SCALE: NONE					
SHEET	REV	JOB NO:	FUNC-TYPE-SIZE	1007804	
200	02	C17581	F-01-D		

Drawing Number

Figure 1: Drawing Label

Reference Drawing:

System Riser Diagram **DWG-1007804**

Daktronics identifies manuals by the DD or ED number located on the cover page.

Console Revision History

For a complete history of revisions to the console firmware, refer to **All Sport & OmniSport Revision Histories (DD3679410)**, available online at www.daktronics.com/manuals.

Daktronics Exchange and Repair & Return Programs

Exchange Program

The Daktronics Exchange Program is a service for quickly replacing key components in need of repair. If a component fails, Daktronics sends a replacement part to the customer who, in turn, returns the failed component to Daktronics. This decreases equipment downtime. Customers who follow the program guidelines explained below will receive this service.

Before contacting Daktronics, identify these important numbers:

Assembly Number: _____

Job/Contract Number: _____

Date Manufactured/Installed: _____

Daktronics Customer ID Number: _____

To participate in the Exchange Program, follow these steps:

1. Call Daktronics Customer Service.

United States & Canada: 1-800-DAK-TRON (325-8766)

Outside the U.S. & Canada: +1-605-275-1040

2. When the new exchange part is received, mail the old part to Daktronics.

If the replacement part fixes the problem, send in the problem part being replaced.

- a. Package the old part in the same shipping materials in which the replacement part arrived.
 - b. Fill out and attach the enclosed UPS shipping document.
 - c. Ship the part to Daktronics.
- 3. The defective or unused parts must be returned to Daktronics within 5 weeks of initial order shipment.**

If any part is not returned within five (5) weeks, a non-refundable invoice will be presented to the customer for the costs of replenishing the exchange parts inventory with a new part. Daktronics reserves the right to refuse parts that have been damaged due to acts of nature or causes other than normal wear and tear.

Repair & Return Program

For items not subject to exchange, Daktronics offers a Repair & Return Program. To send a part for repair, follow these steps:

1. Call Daktronics Customer Service.

United States & Canada: 1-800-DAK-TRON (325-8766)

Outside the U.S. & Canada: +1-605-275-1040

2. Receive a case number before shipping.

This expedites repair of the part.

3. Package and pad the item carefully to prevent damage during shipment.

Electronic components, such as printed circuit boards, should be placed in an antistatic bag before boxing. Daktronics does not recommend using packing peanuts when shipping.

4. Enclose:

- name
- address
- phone number
- the case number
- a clear description of symptoms

5. Ship to:

Daktronics Customer Service

[Case #]

201 Daktronics Drive, Dock E

Brookings, SD 57006

Daktronics Warranty & Limitation of Liability

The Daktronics Warranty & Limitation of Liability is located at the end of this manual. The Warranty is independent of Extended Service agreements and is the authority in matters of service, repair, and display operation.

2 Basic Operation

Console Operation

The console face consists of a 2-line by 16-character liquid crystal display (LCD), number/menu keypads, horn/clock controls with LED status indicators, and an area for a sport-specific insert. Refer to **Figure 2** to locate these components on the control console face.

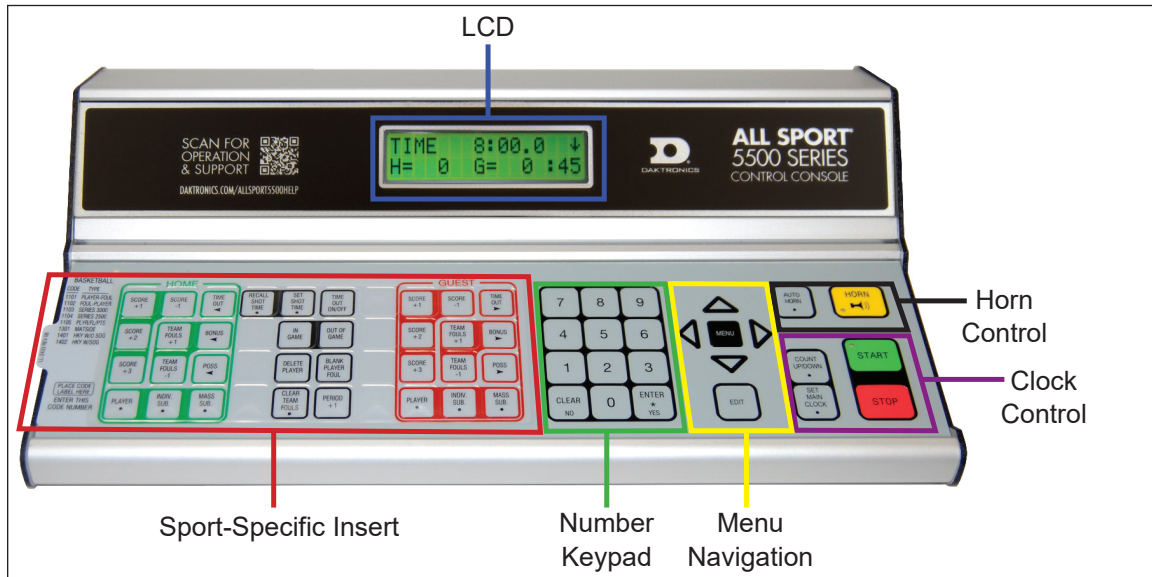

Figure 2: All Sport 5500 Layout

In most cases, the top line of the LCD shows the main clock time, direction the clock is counting, and when the main horn is sounding, while the bottom line typically shows the HOME and GUEST team scores.

The standard fixed keys and functions on the right side of the console are explained in **Standard Keys (p. 6)**. All of the keys that pertain to a specific sport code insert are explained in detail in their respective sport section.

In addition, Quick References and Menu Flowcharts for the Standard Keys and many of the more common individual sports are provided in **Appendix D**.

Throughout this manual, the names or letters of keys on the keypad are enclosed in angle brackets (such as <ENTER>).

Sport Inserts

Sport inserts allow one console to control multiple sports. Select the proper insert from the chart below and slide it into the insert opening on the left side of the console until it stops. To remove a sport insert, pull on the tab that extends from the left side of the console.

If an insert is lost or damaged, a printed copy of the insert drawing from **Appendix B** may be used until a replacement can be ordered. Print this page (if viewing digital copy) and write the code number in the following table for all applicable sports.

If the code number for a scoreboard is unknown, refer to **Appendix C**. If the model number of a scoreboard is unknown, refer to the documentation provided with the scoreboard.

Sport	Insert Number	Number Code
Basketball	LL-2433	
Segment Timer	LL-2475	Not applicable
Volleyball	LL-2434	
Wrestling	LL-2435	

A sport insert identifies the keys required for normal operation of a specific sport. In most cases, pressing a key immediately changes the scoreboard. Keys that require entry of additional information are marked by a dot. This additional information is usually a number followed by the **<ENTER>** key.





Keys with arrows activate an indicator (possession, bonus, etc.) on the scoreboard. The direction of the arrow selects the appropriate team (home or guest).

Some keys are labeled **+1**, **+2**, or **+3**. By pressing one of these keys once, the corresponding field on the scoreboard (such as score or period) "increments", or increases, by the amount printed on the key. A key with **-1** "decrements", or decreases, by one.

On most inserts, certain keys have been grouped together under the heading **Home** or **Guest**. These keys are **team** keys and work the same for both teams. They affect the statistics only for that one team. Keys not under one of these headings are **game** keys. They are general keys for the progress of the game (such as period or quarter). Other keys may be grouped in a similar way to emphasize that they work together.

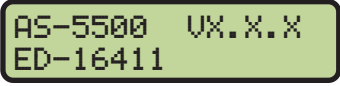
Start Up

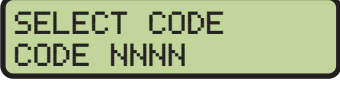
Use the switch on the back of the console to turn it on, then follow the LCD screens:

Display	Action
 <p>AS-5500 UX.X.X ED-16411</p>	<p>The console performs a self-test when it is powered on. During the self-test, a message displays the version of the standard software loaded in the console.</p> <p>V = version number and revision number ED = standard software number</p>
 <p>PREV CODE NNNN RESUME GAME?</p> <p>NNNN = last code selected</p>	<p>When the self-test completes, a prompt displays the code number for the last game played. This is useful when power to the console is lost during a game.</p> <p>Press <YES> to resume the last game stored in memory. The console is now ready for game operation.</p> <p>Press <NO> to start a new game or change to a different sport. The console will prompt for a new code number.</p>
 <p>SELECT CODE CODE NNNN</p> <p>NNNN = current code</p>	<p>The SELECT CODE prompt lets the operator accept the last code selected (shown on the second line) or enter a new code.</p> <p>To accept the code shown, press <ENTER>.</p> <p>To select a new sport code:</p> <ol style="list-style-type: none"> 1. Get the code number from the sport insert or the section of the manual for that sport. 2. Use the number keys to enter the new four-digit code. 3. Press <ENTER>.
 <p>RADIO SETTINGS BCAST X CHAN YY</p> <p>X = last broadcast number YY = last channel number</p>	<p>If a new code is selected, and the radio option is installed, the console prompts for a broadcast group and channel. When Resume Game is used, the last selected settings are used.</p> <p>Press <ENTER> to accept the group and channel numbers, or press <CLEAR> to enter new numbers.</p> <p>Refer to Setting Radio Channels (p. 10) for more information.</p>

Standard Keys

Start

<START> is used to start the main clock. The green LED on the **<START>** key is on while the main clock is running.

Stop

<STOP> is used to stop the main clock. The green LED on the **<START>** key is off while the main clock is stopped.

Enter/Yes

The **<ENTER/YES*>** key has two functions:

- Completes an action. As a reminder to press this key, an asterisk appears on the LCD.
- Serves as **<YES>** for input prompts (**Y**).

Clear/No

The **<CLEAR/NO>** key has two functions:

- Clears the LCD of numerical information.
- Serves as **<NO>** for input prompts (**N**).

The **<CLEAR/NO>** key also acts as an escape during data entry. The number of key presses to escape depends on the step in the entry process (flashing asterisk or not).

Example 1: The operator presses the **<SET MAIN CLOCK>** key to adjust the game time.

- If no number key has been pressed yet, press the **<CLEAR/NO>** key once to escape.
- If any number key has been pressed, the **<CLEAR/NO>** key must be pressed twice to escape; the first press blanks the data on the LCD, and the second press escapes.

Example 2: The operator presses **<EDIT>** followed by a **<SCORE>** key to change the score:

- The **<CLEAR/NO>** key must always be pressed twice to escape.

Edit

Press the **<EDIT>** key followed by one of the increment or decrement keys for the desired field on the scoreboard to modify. Then simply enter the new value to display and press **<ENTER>** to accept.

Menu

Press **<MENU>** to access general and sport-specific options. Use the up and down arrow keys to scroll through the menu list. Press **<MENU>** again at any time to return to the game in progress. Refer to **Menu (p. 14)** for more information.

Set Main Clock

Display	Action
The LCD display shows the text "MAIN CLOCK -SET" on the top line and "CURR MM:SS.T *" on the bottom line. The asterisk is flashing. MM:SS.T = minutes, seconds, tenths of a second	After the main clock has been stopped, press <SET MAIN CLOCK> to display the current time of the main clock. To change the time, enter the desired value using the number pad, and then press <ENTER> . Press <CLEAR> twice to clear changes and return to the game.
The LCD display shows the text "MAIN CLOCK -EDIT" on the top line and "PERIOD MM:SS *" on the bottom line. The asterisk is flashing. MM:SS = minutes, seconds	Press <SET MAIN CLOCK> two times to display the configured time for the main clock period length. To change the period length and set the main clock, enter the new time in minutes and seconds using the number pad, and then press <ENTER> . Note: Pressing <ENTER> to select the period time as the main clock setting will increment the current period number if the clock value was previously zero. Press <CLEAR> twice to clear changes and return to the game.

Display	Action
<p>MM:SS = minutes, seconds</p>	<p>Press <SET MAIN CLOCK> three times to display the configured time for break length.</p> <p>To change the break length and set the main clock, enter the new time in minutes and seconds using the number pad, and then press <ENTER>.</p> <p>Press <CLEAR> twice to clear changes and return to the game.</p>
<p>MM:SS = minutes, seconds</p>	<p>Press <SET MAIN CLOCK> four times to display the configured time for overtime length.</p> <p>To change the overtime length and set the main clock, enter the new time in minutes and seconds using the number pad, and then press <ENTER>.</p> <p>Press <CLEAR> twice to clear changes and return to the game.</p>
<p>MM:SS = minutes, seconds</p>	<p>Press <SET MAIN CLOCK> five times to display the configured time for pre-game length.</p> <p>To change the pre-game length and set the main clock, enter the new time in minutes and seconds using the number pad, and then press <ENTER>.</p> <p>Press <CLEAR> twice to clear changes and return to the game.</p>
<p>MM:SS = minutes, seconds</p>	<p>Press <SET MAIN CLOCK> six times to display the configured time for post-game length.</p> <p>To change the post-game length and set the main clock, enter the new time in minutes and seconds using the number pad, and then press <ENTER>.</p> <p>Press <CLEAR> twice to clear changes and return to the game.</p>

Note: To blank the game time while keeping the rest of the scores and statistics visible: Press **<SET MAIN CLOCK>**, any number key, **<CLEAR>**, and then **<ENTER>**.

Count Up/Down

Display	Action
	<p>After the main clock has been stopped, the direction of the clock can be set.</p> <p>Press <1> or <2> to select UP or DOWN (default).</p> <p>Note: The current direction of the main clock is shown on the top line of the LCD.</p>

Auto Horn

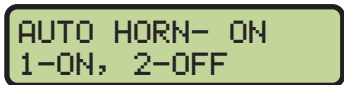
Display	Action
	Press <1> to select ON (default), or press <2> to select OFF. The amber LED on the <HORN> key is on when the Auto Horn feature is enabled. The LED is off when the Auto Horn feature is disabled and the horn is in Manual mode.

Manual Horn

Press <HORN> to sound the main horn. The horn sounds as long as the key is pressed.

Remote Start/Stop Controls

The All Sport 5500 console lets additional operators control timing functions remotely using the Main Clock Start/Stop switch and the Shot Clock Start/Stop switch.

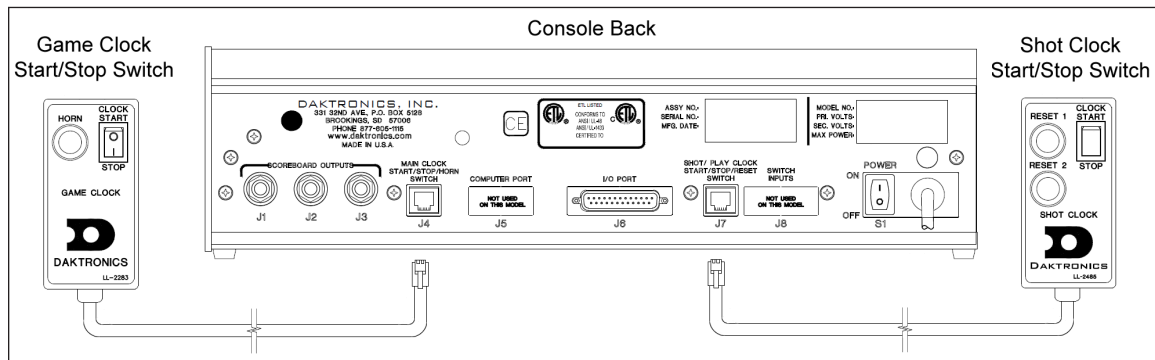

Figure 3: Remote Start/Stop Switches

Main Clock Control

The Main Clock Start/Stop switch plugs into **J4** on the back of the console (**Figure 3**). This unit has a rocker switch for clock start/stop and a button for horn. The horn button sounds the horn as long as the button is pressed.

Shot Clock Control

The Shot Clock Start/Stop switch plugs into **J7** on the back of the console (**Figure 3**). This unit has a rocker switch for Start/Stop and reset button(s). When a reset button is pressed, the shot clock timer is changed to the reset value and stops the timer from decrementing. The shot clock timer restarts when the reset button is released. In independent mode, the switch starts and stops the shot clock timer when pushed, but does not stop when the main clock is stopped. When in synchronized mode, the shot clock timer will stop and start with the main clock switches only if it is running in the beginning.

Refer to **Section 4: Basketball Operation (p. 25)** for sport-specific information about shot clock configurations.

Setting Radio Channels

Reference Drawings:

Channel Selection; Multiple Broadcast Group, Gen IV **DWG-203113**
Installation Details, Gen VI Channel Selection Guide **DWG-1109870**

The radio receiver units used in Daktronics scoreboards have a channel (CHAN) switch that can be set from 1–8. The receivers also have a broadcast group (BCAST) setting. The broadcast group defines a group of radio receivers that “listen” to the channel selected on the channel switch as well as “listen” for data sent out on their broadcast channel.

Note: The number of available broadcast groups varies depending on the generation of radio receiver: Gen V receivers have 1–4, while Gen VI receivers have 1–8.

Each radio receiver will accept data sent from the broadcast channel of its respective broadcast group, as well as data sent from the “Master Broadcast” channel. This is selected when the console is set to BCAST 0 and CHAN 00.

In this type of system, the receiver unit at the scoreboard must have the channel switch set to a specific channel. The operator must know which channel is selected in the scoreboard. The operator must then enter the specific channel when prompted during console startup.

To determine the settings of a scoreboard, first power it down and shut off any radio-equipped consoles in the area. Next, power the scoreboard back up and watch for the radio settings. The settings will appear as “bX CY” where X is the current broadcast group, and Y is the current channel.

The settings are typically displayed in the clock digits or Home and Guest score digits, depending on the scoreboard model. Refer to **Figure 4**.

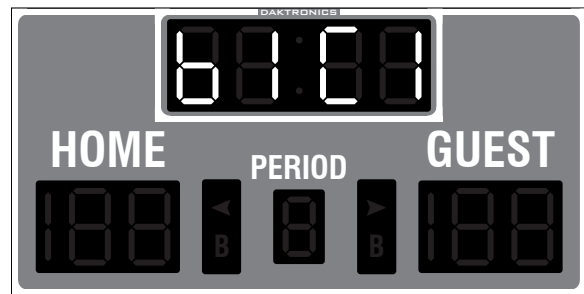

Figure 4: Radio Settings in Clock Digits

The console automatically detects when a radio transmitter is installed and will prompt the operator for transmitter settings after a valid sport code is entered.

Note: If interference from a nearby Daktronics system is suspected, press **<CLEAR>** at the “RADIO SETTINGS” prompt to change the channel number.

There are three different radio scenarios that can be accommodated: a single controller system, a multiple controller system with a single broadcast group, and a multiple controller system with multiple broadcast groups. These scenarios are described on the following pages.

Single Controller System

In a single controller system (**Figure 5**), all radio receivers and all scoreboards receive signal from the same console. The default channel and broadcast group settings on the receiver are not typically modified. An example of this type of system is a gymnasium with a scoreboard on one or both end walls displaying the same information.

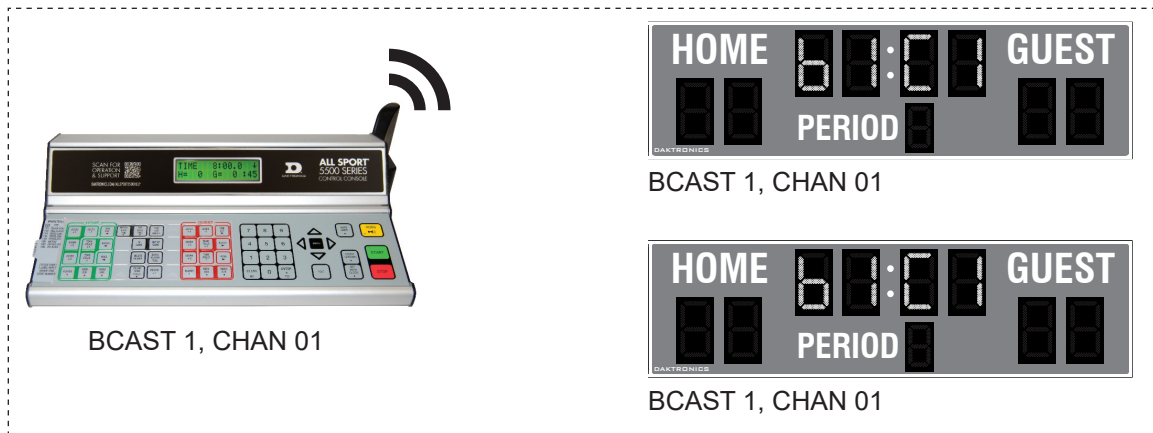

Figure 5: Single Control Console

Typically all single controller systems will use the default setting BCAST = 1, CHAN = 1. All radio receivers in the system must be set to the same values.

Display	Action
<p>The LCD will toggle between these 2 screens:</p> <div style="border: 1px solid black; padding: 5px; margin-bottom: 10px;"> <p>RADIO SETTINGS BCAST X CHAN YY</p> </div> <div style="border: 1px solid black; padding: 5px; margin-bottom: 10px;"> <p>ENTER TO ACCEPT CLEAR TO MODIFY</p> </div> <div style="border: 1px solid black; padding: 5px;"> <p>BCAST GROUP X* RADIO CHAN YY</p> </div> <p>X = broadcast group number YY = channel number</p>	<p>The LCD shows the current radio settings along with a prompt to accept or modify these values.</p> <p>If the radio settings are correct press <ENTER>.</p> <p>If these values are incorrect, press <CLEAR>, and the LCD at bottom left is shown, allowing edit of the channel or broadcast group setting.</p> <p>Broadcast Group Setting [1] Use this setting for all single controller systems. Use the number keys to edit this value and press <ENTER> to accept. The asterisk will move to the channel setting.</p> <p>Channel Setting [1-8] Edit the channel number to the desired value and press <ENTER> to accept. The CHAN switch on the receiver must match this value.</p>

Multiple Controller System with Single Broadcast Group

In a multiple controller system with a single broadcast group (**Figure 6**), there may be one console for each scoreboard and/or one master controller that can run every scoreboard at one time or take control of a specific scoreboard. An example of this type of system is a softball complex with individual scoreboards on several different fields.

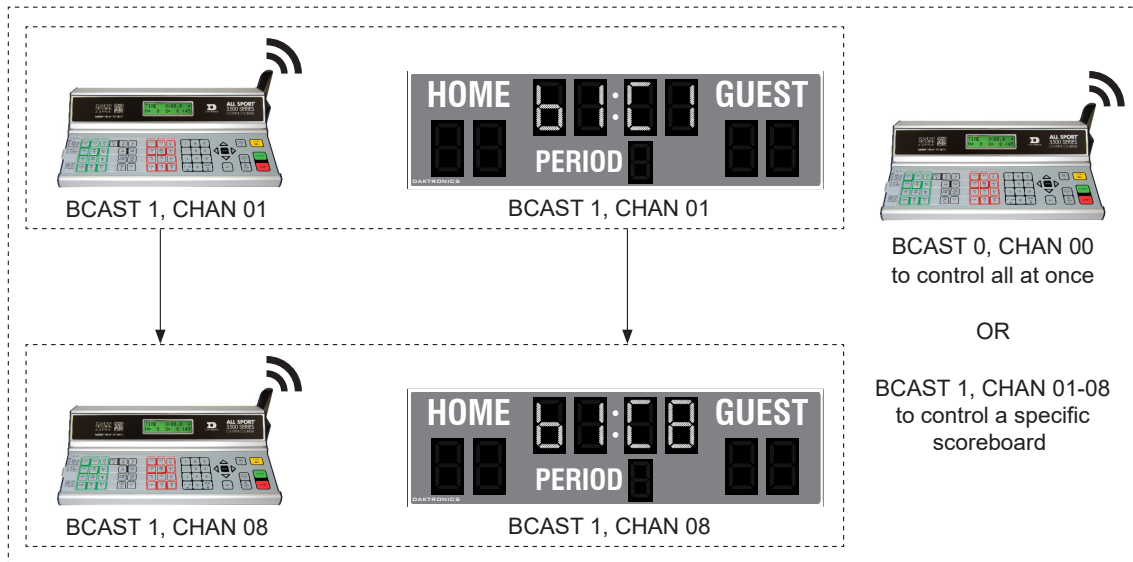

Figure 6: Single Broadcast Group

Multiple controller systems typically use Broadcast 1 and Channel 1 for the first controller and Channels 1-8 for all remaining controllers. All radio receivers in the system must be set to Broadcast 1 (BCAST 1).

Display	Action
<p>The LCD will toggle between these 2 screens:</p> <div style="border: 1px solid black; padding: 5px; margin-bottom: 10px;"> <p>RADIO SETTINGS BCAST X CHAN YY</p> </div> <div style="border: 1px solid black; padding: 5px; margin-bottom: 10px;"> <p>ENTER TO ACCEPT CLEAR TO MODIFY</p> </div> <div style="border: 1px solid black; padding: 5px;"> <p>BCAST GROUP X* RADIO CHAN YY</p> </div> <p>X = broadcast group number YY = channel number</p>	<p>The LCD shows the current radio settings along with a prompt to accept or modify these values.</p> <p>If the radio settings are correct press <ENTER>.</p> <p>If these values are incorrect, press <CLEAR>, and the LCD at bottom left is shown, allowing edit of the channel or broadcast group setting.</p> <p>Broadcast Group Setting [1] Use this setting for all multiple controllers with single broadcast group setups. Use the number keys to edit this value and press <ENTER> to accept. The asterisk will move to the channel setting.</p> <p>Channel Setting [1-8] Edit the channel number to the desired value and press <ENTER> to accept. The CHAN switch on the receiver must match this value.</p>

Multiple Controller with Multiple Broadcast Groups

In a multiple controller system with multiple broadcast groups (**Figure 7**), there are many consoles that control multiple scoreboards and/or scoreboard groups. The radio receiver inside the scoreboard is set to broadcast group 1-4 (Gen V) or 1-8 (Gen VI). By changing the console settings to the specific broadcast group address, a single console can control all scoreboards or specific groups of scoreboards. One example of this scenario is split court operation in basketball installations, where scoreboards are used to score multiple games at once, but can be grouped together to show one game if necessary.

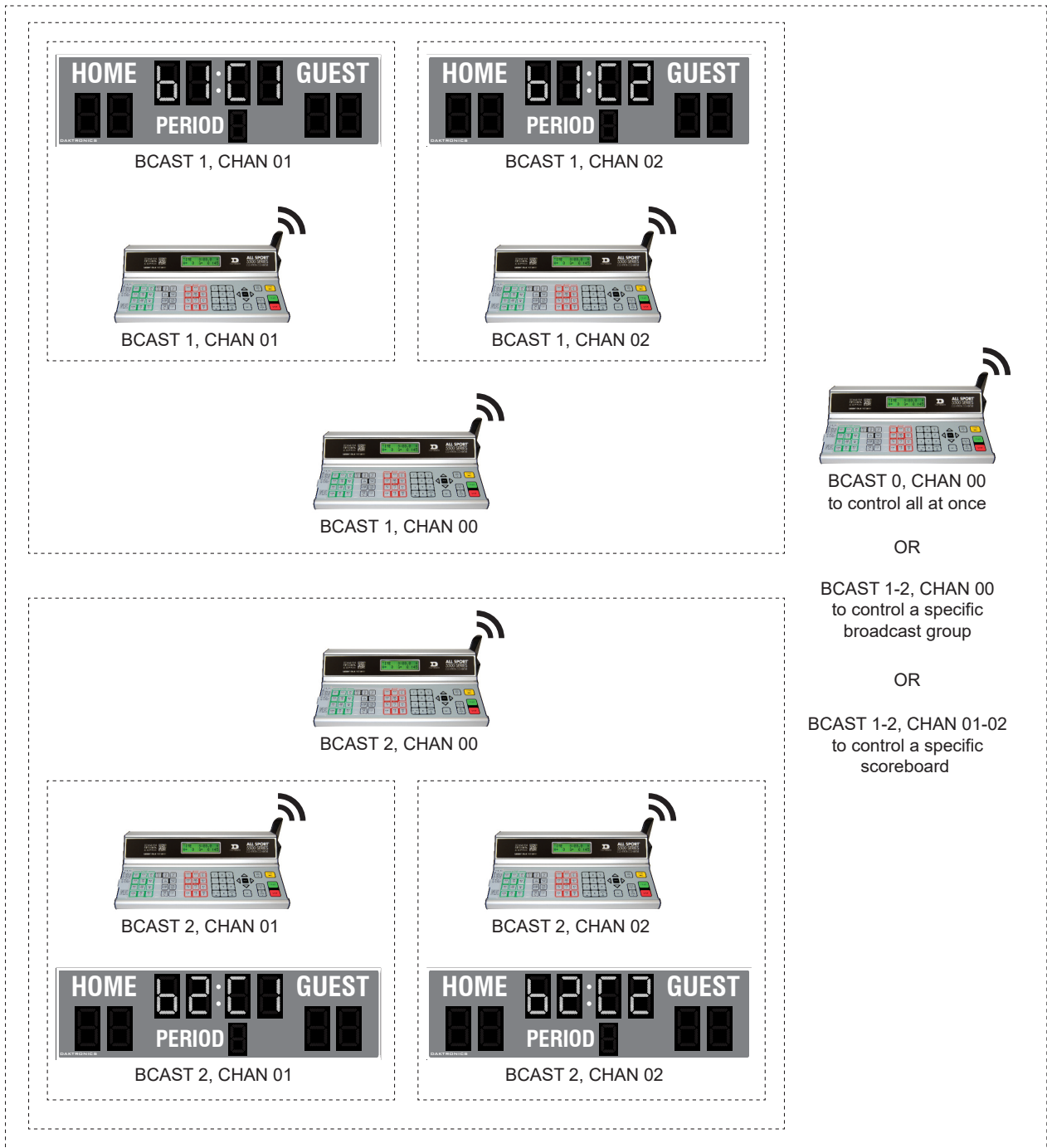

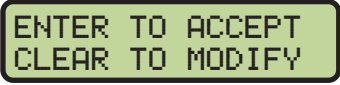



Figure 7: Multiple Broadcast Group

Typically, all multiple controller systems will use BCAST 1, CHAN 1 for the first controller in Broadcast Group 1 and BCAST 2, CHAN 1 for the first controller in Broadcast Group 2. All other consoles in a group are added sequentially.

Display	Action																			
<p>The LCD will toggle between these 2 screens.</p>    <p>X = broadcast group number YY = channel number</p>	<p>The LCD shows the current radio settings along with a prompt to accept or modify these values.</p> <p>If the radio settings are correct press <ENTER>.</p> <p>If these values are incorrect, press <CLEAR>, and the LCD at bottom left is shown, allowing edit of the channel or broadcast group setting.</p> <p>Use the number keys to enter the desired broadcast group and press <ENTER> to accept. The asterisk will move to the channel setting.</p> <p>Edit the channel number to the desired value and press <ENTER> to accept.</p> <table border="1"> <thead> <tr> <th>Broadcast Group</th> <th>Channel Setting</th> <th>Control Scoreboards</th> </tr> </thead> <tbody> <tr> <td>0</td> <td>0</td> <td>All Scoreboards</td> </tr> <tr> <td rowspan="2">1</td> <td>0</td> <td>All in BCAST Group 1</td> </tr> <tr> <td>1-8</td> <td>Set to corresponding BCAST 1 Channel</td> </tr> <tr> <td>↓</td> <td>↓</td> <td>↓</td> </tr> <tr> <td rowspan="2">8*</td> <td>0</td> <td>All in BCAST Group 8</td> </tr> <tr> <td>1-8</td> <td>Set to corresponding BCAST 8 Channel</td> </tr> </tbody> </table> <p>* Gen V radio receivers have only 4 groups; also, on broadcast groups 2 and 4, only channels 1-4 may be used.</p>	Broadcast Group	Channel Setting	Control Scoreboards	0	0	All Scoreboards	1	0	All in BCAST Group 1	1-8	Set to corresponding BCAST 1 Channel	↓	↓	↓	8*	0	All in BCAST Group 8	1-8	Set to corresponding BCAST 8 Channel
Broadcast Group	Channel Setting	Control Scoreboards																		
0	0	All Scoreboards																		
1	0	All in BCAST Group 1																		
	1-8	Set to corresponding BCAST 1 Channel																		
↓	↓	↓																		
8*	0	All in BCAST Group 8																		
	1-8	Set to corresponding BCAST 8 Channel																		

Menu

Press **<MENU>** to access general and sport-specific options. Use the up and down arrow keys to scroll through the menu list. Press **<MENU>** again at any time to return to the game in progress. Menu settings common to most sport modes are shown below. Refer to individual sport mode sections for additional menus and settings.

New Game

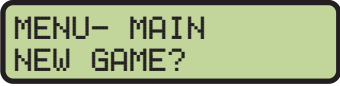
Display	Action
	<p>Press <ENTER> to clear all data for the current game in progress and begin a new game.</p>

New Code

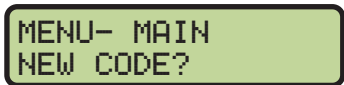
Display	Action
	Press <ENTER> to switch to a different sport code through the SELECT CODE prompt. Refer to Start Up (p. 6) for more information on sport codes.



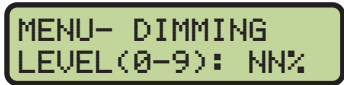

Dimming Menu

The **Dimming Menu** changes the brightness of the scoreboard.

Display	Action
 <p>NN = current setting</p> <p>NONE = <0> 50% = <5> 90% = <1> 40% = <6> 80% = <2> 30% = <7> 70% = <3> 20% = <8> 60% = <4> 10% = <9></p>	Press <0> (brightest) through <9> (dimkest) or use the left/right arrow keys to set the scoreboard digit dimming level.

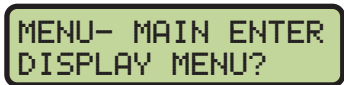
Display Menu

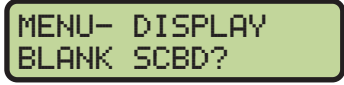
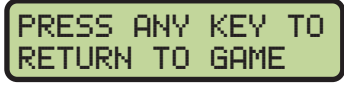
Use the **Display Menu** to start and edit the segment timer, blank the scoreboard, enable/disable the clock captions, and more.

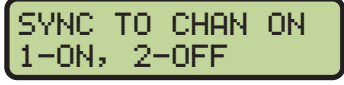
Display	Action
	Press <ENTER> to select the Display submenu.
 	Press <ENTER> twice to exit the sport code and run the segment timer function. Note: The clock must be stopped to access the segment timer. Insert the SEGMENT TIMER (LL-2475) insert and refer to Section 3: Segment Timer Operation (p. 20) for more information.
 	Press <ENTER> to select the blank scoreboard feature. The scoreboard will go blank and wait for the operator to press any key to resume normal operation.
 	Press <ENTER> to view or set the radio sync to channel setting. The LCD will show if the setting is ON or OFF. Press <1> to turn it on, or press <2> to turn it off. Note: This setting should remain ON unless instructed by Daktronics to turn it off.

Display	Action
<pre>MENU- DISPLAY CLOCK CAPTIONS</pre> <pre>CLOCK CAPTION- 1-ON, 2-OFF ON</pre>	<p>Press <ENTER> to view or set the clock caption setting.</p> <p>The LCD will show if the setting is ON or OFF. Press <1> to turn it on, or press <2> to turn it off.</p>
<pre>MENU- DISPLAY SET RTD OFFSET</pre> <pre>RTD OFFSET 0K 0 1=5 2=10 3=15</pre>	<p>Press <ENTER> to set the RTD offset.</p> <p>The RTD offset is typically used when there are multiple consoles in the same area, and one or more matrix displays showing their information (for example, during a tournament).</p> <p>Press <1> to offset the RTD by 5000, <2> to offset by 10000, or <3> to offset by 15000. Press <0> to clear the offset.</p>
<pre>MENU-DISPLAY RUN DOWNLOAD Y/N?</pre>	<p>This menu is used to download and transfer field update files to certain scoreboard drivers. For more information, refer to ED-18728 in Appendix E.</p>

Color Menu

Use the Color Menu to select the color-changing settings for the clock and score digits.

Display	Action
<pre>MENU- MAIN ENTER COLOR MENU</pre>	<p>Press <ENTER> to select the Color submenu.</p>
<pre>COLOR MENU CLOCK COLOR</pre> <pre>CLOCK COLOR -ON 1-ON, 2-OFF</pre> <pre>ALERT TIME MM:SS*</pre> <p>MM:SS = minutes, seconds</p> <pre>CLOCK DEFAULT COLOR =GRN</pre>	<p>Press <ENTER> to select the clock color selection.</p> <p>The current setting for clock color control will be shown as ON or OFF. Press <1> to set ON or <2> to set OFF.</p> <p>If set ON, the clock color will be green for RUN and red for STOP. The operator can set an alert time when the clock will go amber. Set the alert time to 0:00 if none is used.</p> <p>If the clock color control is set OFF, the operator can select a default color for the clock. Press the up or down arrow key to select a color.</p>

Display	Action
<p>COLOR MENU SCORE COLOR</p> <p>SCORE COLOR -ON 1-ON, 2-OFF</p> <p>HIGH SCORE COLOR =GRN</p> <p>LOW SCORE COLOR =RED</p> <p>TIE SCORE COLOR =AMB</p> <p>HOME SCORE COLOR =GRN</p> <p>GUEST SCORE COLOR =RED</p>	<p>Press <ENTER> to select the score color selection.</p> <p>The current setting for score color control will be shown as ON or OFF. Press <1> to set ON or <2> to set OFF.</p> <p>If set ON, the color of the score can be selected for the larger, smaller, and tied score.</p> <p>Press the up or down arrow key to select a color. Press <ENTER> when the desired color is shown.</p> <p>If set to OFF, the default color for HOME and GUEST scores can be selected.</p> <p>Press the up and down arrow key to select a color. Press <ENTER> when the desired color is shown.</p>

Time of Day

Display	Action
<p>MENU- MAIN SELECT TOD?</p>	<p>Press <ENTER> to select the Time of Day (TOD) submenu.</p>
<p>MENU-TIME OF DAY 1*12, 2-24 HOUR</p>	<p>Press <1> to display the time of day in 12 hour (default), or press <2> to display the time of day in 24 hour format.</p>
<p>MENU-TIME OF DAY TOD HH:MM:SS*</p> <p>HH:MM:SS = hours, minutes, seconds</p>	<p>Enter the time of day in hours, minutes, and seconds using the number pad, and then press <ENTER>.</p>
<p>MENU-TIME OF DAY 1*GAME 2-TOD</p> <p>MENU-TIME OF DAY BLANK GAME DATA?</p>	<p>Press <1> to display the game clock (default), or press <2> to display the time of day on the scoreboard clock digits.</p> <p>If 2-TOD is selected, press <ENTER> to blank all game data on the scoreboard except for the Time of Day digits, or press <CLEAR> to leave the game data visible.</p>

Switch Output

The All Sport 5500 console has a relay switch that can be used to control external devices. The switch can be configured to operate under different clock or horn conditions. The default setting is **1-CLOCK= 0**.

1. Press the number key (<0>, <1>, <2>, <3>) as a shortcut or use the left and right arrow keys to select the desired setting.
2. Press <YES> to select the new setting, or press <NO> to leave the switch setting as is.

The possible settings for the switch output are displayed below:

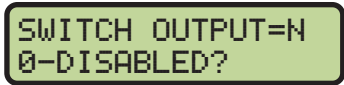
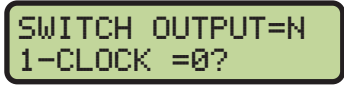
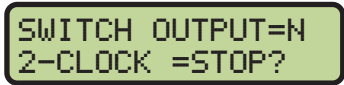
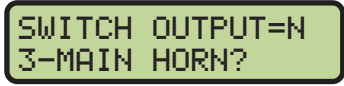
Display	Action
 <p>N = current setting</p>	The switch remains open at all times and any external devices are disabled.
 <p>N = current setting</p>	In count down mode, the switch closes when the main clock reaches zero and stays closed until a nonzero value is entered. In count up mode, the switch closes when the main clock reaches the proper period, break, or overtime length and opens when any other value is entered.
 <p>N = current setting</p>	The switch closes when the main clock is stopped and opens when the main clock is running. External devices are disabled when the main clock is running.
 <p>N = current setting</p>	The switch closes when the main horn sounds. This could be when Auto Horn is enabled and the main clock reaches zero or when <HORN> is pressed.

General Multi-Purpose Timer

There is no insert for the Multi-Purpose Timer codes. Code 99 is used to operate the multi-purpose timer.

The Multi-Purpose Timer is a general timer used for 2-, 4-, and 6-digit time displays. The timer will count up or down through hours, minutes, and seconds. The information will shift on the 2- and 4-digit displays to show the most significant time values as the time changes. The Multi-Purpose Timer code is also used as a Time-of-Day code by accessing the Time of Day Menu through the Menu key. The Segment Timer may also be accessed using the Menu key.

Standard Keys

The keys that are used by the multi-purpose timer are <START>, <STOP>, <SET MAIN CLOCK>, <COUNT UP/DOWN>, <AUTO HORN>, <MANUAL HORN> and <MENU>. The key functions are explained in more detail in **Standard Keys (p. 6)**.

Segment Timer

Refer to **Section 3: Segment Timer Operation (p. 20)** for details on accessing and operating the segment timer function.

Team Name Entry

Certain scoreboards may be equipped with Team Name Message Centers (TNMCs), LED matrix displays that show team names, abbreviations, or short messages.

The team name entry function is typically accessed by pressing the **<MENU>** key and navigating to the HOME or GUEST TEAM NAME option (refer to an individual sport section for more information).

The TEAM NAME insert (LL-2441) is used to enter the TNMC settings. For newer consoles, the Team Name insert is printed directly on the keypad; for older consoles; it will be necessary to swap the sport insert with a separate insert. The TEAM NAME insert has the following sections for controlling the appearance of the display:

WIDTH

Select the width (in pixels) of the TNMC from 16, 32, 48 or 64 columns. The default width is 48 columns long.

HEIGHT

Select the height (in pixels) of the TNMC from 7 or 8 rows. The default height is 8 rows high.

FONT

Select a Single Stroke or a Double Stroke (bold) font. The default font is single stroke. Each TNMC on a scoreboard (Home & Guest) may use different font settings to fit varying team name lengths.

The tables below show the width (in pixels) of every character for each font setting:

TNMC Font	A	B	C	D	E	F	G	H	I	J	K	L	M	N	O	P	Q	R	S	T	U	V	W	X	Y	Z
Single Stroke - Standard	4	4	4	4	4	4	4	4	3	4	4	4	5	4	4	4	5	4	4	5	4	5	5	5	5	4
Single Stroke - Alternate Narrow*	3	3	3	3	3	3	4	3	1	3	4	3	5	4	3	3	5	3	3	3	3	5	5	5	3	4
Double Stroke - Standard	6	6	6	6	6	6	6	6	4	6	6	6	7	6	6	6	7	6	6	6	6	7	7	7	6	6
Double Stroke - Alternate Narrow*	5	5	5	5	4	4	6	5	2	5	6	4	7	6	5	5	7	5	5	4	5	7	7	7	6	6

*To access Alternate Narrow fonts, press the **<SHIFT>** key before pressing a letter key. A lowercase letter is shown on the LCD to represent the Alternate Narrow characters.

TNMC Font	1	2	3	4	5	6	7	8	9	0	&	'	,	-	.
Single Stroke - Standard	3	4	4	5	4	4	4	4	4	4	5	2	2	3	1
Double Stroke - Standard	4	6	6	7	6	6	6	6	6	6	5	3	3	3	2

3 Segment Timer Operation

Sport Insert: LL-2475 (Code 100 is for the dedicated Segment Timer)

The Sport Insert drawing is located in **Appendix B**. The Quick Reference is located in **Appendix D**.

Reference Drawings:

Insert, Segment Timer **DWG-129357**

Refer to **Section 2: Basic Operation (p. 4)** for information on how to start up the console and use the sport insert.

If an insert is lost or damaged, a copy of the insert drawing can be used until a replacement arrives.

If the code number for a scoreboard is unknown, refer to **Appendix C**. If the scoreboard model number is unknown, refer to the documentation provided with the scoreboard.

Segment Timer Overview

The segment timer is a multi-function timing system and has multiple purposes. Operation of the segment timer is determined by 99 segments of pre-programmed length. The segment timer will count down starting at the segment number that is set as **First Segment**. When the first segment is completed, the timer will count the preset **Interval Time** and move on to the next segment. The timer will continue counting segments until the segment number that is set as **Last Segment** is complete. It then will reset to the segment saved as the **First Segment** and will either begin counting down or wait for the **<START>** key to be pressed depending on the **<AUTO STOP>** setting. Refer to **Auto Stop (p. 23)** to set the segment-stopping feature.

The **First Segment** and **Last Segment** values can be used to set up specific practice sessions. For example, the practice session for one sport could be programmed for 5 minute segments on segments 1-10 while another might use 10 minute segments on 11-20. Set the **First Segment** and **Last Segment** values to the desired segment numbers for the session and the console will count down each of the segments in order. It may also be set to either stop on the last segment or loop back to the first segment again based on the **<AUTO STOP>** setting.

The segment values will be saved when the console is turned off and will be the same values regardless of the sport that was used to access the segment timer.

Accessing Segment Timer

Turn on the console. Enter the sport code used for the scoreboard in use and press **<ENTER>**. A list of sport codes can be found in **Appendix C**.

The segment timer program is accessed through the main menu of each individual sport.

Display	Action
MENU- MAIN ENTER DISPLAY MENU?	After the main clock has been stopped, press the <MENU> key and press the down or up arrows until the LCD at left is displayed. Press <YES> to enter the display menu.
MENU-DISPLAY RUN SEGMENT TIMER?	Press <YES> to exit the sport code and run the segment timer program. The console will prompt to press <YES> a second time to avoid accidental exit from the sport program.
EXIT GAME ARE YOU SURE?	Refer to Segment Timer Keys (p. 21) for general segment timer operation instructions.

Accessing 2-Digit or 6-Digit Display Segment Timer

This code is only used for the two-digit or six-digit displays designed exclusively for segment timing. Enter code **100** after turning on the console to access the exclusive segment timer program. For scoreboards, enter the correct scoreboard code and use <MENU> to access the segment timer function.

Segment Timer Keys

Segment Number & Time

The <SEG. NO. • TIME •> key is used to edit the time of each segment. Select the segment to be edited, and enter the desired time as described below.

Display	Action
SEGMENT: NN * TIME EDIT NN = current setting	Press <SEG. NO. • TIME •> to set individual segment times. Enter the segment to be edited using the keypad, and then press <ENTER>.
SEGMENT: NN TIME EDIT MM:SS* NN = current setting MM:SS = minutes, seconds	Enter the time for the segment with the keypad. Press <ENTER> to accept the time and move to the next segment time. Press <ENTER> again to exit the function. Press the up or down arrow keys to move to the previous or next segment.

First Segment

This key sets the first segment in a range of segments to run when <START> is pressed.

Display	Action
FIRST SEGMENT NN* NN = current setting	Press <FIRST SEGMENT •> and enter the segment to be set as the first segment. Press <ENTER> to accept the time and exit the function. The console will be reset to the segment selected here when the <RESET TO FIRST SEG> key is pressed.

Last Segment

This key sets the last segment in a range of segments to run when **<START>** is pressed.

Display	Action
 <p>LAST SEGMENT NN*</p> <p>NN = current setting</p>	<p>Press <LAST SEGMENT •> and enter the segment to be set as the last segment. Press <ENTER> to accept the time and exit the function.</p> <p>After the segment set as the last segment is completed, the console will automatically reset to the segment saved as the first segment.</p>

Interval Time

The interval time is the time between each segment. The interval time can be displayed on the Guest score digits using the **<DISPLAY INTERVAL>** key.

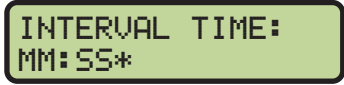
Display	Action
 <p>INTERVAL TIME: MM:SS*</p> <p>MM:SS = minutes, seconds</p>	<p>Press <INTERVAL TIME •> to display the current value of interval time on the bottom line of the LCD. Edit the value of the interval time and press <ENTER>.</p>

Display Interval

This setting determines whether the interval count will be displayed on the scoreboard.

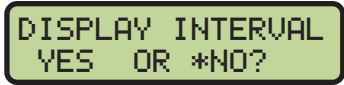
Display	Action
 <p>DISPLAY INTERVAL YES OR *NO?</p>	<p>Press <DISPLAY INTERVAL>.</p> <p>Press <YES> to display the interval time on the scoreboard.</p> <p>Press <NO> to disable interval time display. The interval time will be displayed on the console only if NO is selected.</p> <p>Note 1: Regardless of this setting, the value saved in interval time will be counted down between segments. Set the interval time to zero if no interval between segments is desired.</p> <p>Note 2: When the interval time is being displayed, the segment number on the scoreboard flashes to indicate that the time displayed is interval time.</p>

Copy Range



This key sets a range of segments to a specific value.

Display	Action
 <p>COPY: MM:SS * SEG XX TO YY</p> <p>MM:SS = minutes, seconds XX = starting segment value YY = ending segment value</p>	<p>Press <COPY RANGE •> and enter the time desired. Press <ENTER> to move to the next field. Enter the first and last segments that will have this time. When the last segment in the copy range is set, the menu will be exited.</p> <p>Once completed, all segments from XX to YY (inclusive) will be set to the specified value.</p>

Auto Stop

This key is the auto stop function of the console.

Note: To set the console to stop after the last segment in the series is completed, the auto stop at each segment setting must be set to **NO**.

Display	Action
	Press <AUTO STOP> to enter this menu. Press <YES> to set the console to stop after each segment is completed. Press <START> to proceed with the next segment.
	Press <NO> to set the console to automatically begin the next segment when each segment is completed. The console will prompt for the auto stop at last segment setting. Press <YES> to set the console to stop when the last segment has been completed. Press <NO> to set the console to start over at the first segment when the last segment is completed.

Reset to First

Press **<RESET TO FIRST SEG>** to return to the first segment.

Note: This function is disabled while the clock is running.

Reset Current Segment

Press **<RESET CURRENT SEGMENT>** to reset the segment time to the value specified by the current segment. The segment number will remain at the current value.

Current Segment

Press **<CURRENT SEGMENT +1>** to move to the next segment.

Edit

Current Segment

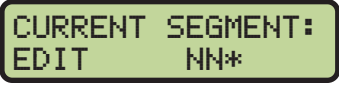
Display	Action
 NN = current setting	Press <EDIT> followed by <CURRENT SEGMENT + 1> to display the current segment for editing. Enter the new value for the current segment number and press <ENTER> .

Menu

Press **<MENU>** to access general and sport-specific options. Use the up and down arrow keys to scroll through the menu list. Press **<MENU>** again at any time to return to the game in progress.

New Code

Display	Action
	Press <ENTER> to switch to a different sport code through the SELECT CODE prompt. Refer to Start Up (p. 6) for more information on sport codes.

Warning Time

Display	Action
<p>MM:SS = minutes, seconds</p>	Enter the warning time in minutes and seconds, and then press <ENTER> . Enter 00:00 for no warning time (default). When the warning time is reached, the segment number flashes until the main clock reaches zero.

Dimming Menu

Refer to **Dimming Menu (p. 15)**.

Default Settings

Print this page if necessary, and record any custom settings for this installation:

Setting	Default	Custom 1	Custom 2	Custom 3	Custom 4
First Segment	1				
Last Segment	99				
Warning Timer	00:00				
Display Interval	No				
Auto Stop on Each Segment	No				
Auto Stop At Last Segment	Yes				

4 Basketball Operation

Sport Insert: LL-2433

The Sport and Team Name Insert drawings are located in **Appendix B**. The Block Diagram drawings are located in **Appendix A**. The Quick Reference is located in **Appendix D**.

Reference Drawings:

Insert, Basketball, LL-2433.....	DWG-120121
Block Diagram: AS5000 BB- VB and WR #1.....	DWG-124686
Block Diagram: AS5000 BB- VB and WR #3.....	DWG-124688
Insert; LL-2442 A/S 5000, Team Name.....	DWG-125290
Block Diagram- A/S 3000 or 5000 BB- VB and WR #2.....	DWG-125415

Refer to the information in **Section 2: Basic Operation (p. 4)** to start up the console and how to use the sport insert.

If an insert is lost/damaged, use a copy of the insert drawing until a replacement arrives.

Use the label sheet provided with the console (Daktronics part # LL-2458) to attach the correct code number label to the sport insert in the designated location. Write the code number in the space below. If viewing a digital copy of this manual, print this page and fill in the code number.

Write the correct code number here:

--	--	--	--

If the code number for a scoreboard is unknown, refer to **Appendix C**. If the scoreboard model number is unknown, refer to the documentation provided with the scoreboard.

Basketball Keys

Set Shot Time

Display	Action
<div style="border: 1px solid black; padding: 5px; margin-bottom: 5px; background-color: #e0e0e0;"> SHOT CLOCK-EDIT CURR MM:SS* </div> <p>MM:SS = minutes, seconds</p>	<p>Press <SET SHOT TIME > to display the current shot clock time.</p> <p>To accept the current shot clock time and return to the game, press <ENTER>.</p> <p>To edit the shot time, use the number pad to enter the new shot time in minutes and seconds, and then press <ENTER>.</p> <p>To discard the edited time, press <CLEAR> twice to clear the changes and return to the game.</p>
<div style="border: 1px solid black; padding: 5px; margin-bottom: 5px; background-color: #e0e0e0;"> SHOT CLOCK-EDIT RESET 1 MM:SS* </div> <p>MM:SS = minutes, seconds</p>	<p>Press <SET SHOT TIME > two times to display the configured shot clock Reset 1 time.</p> <p>To accept the shot clock Reset 1 time and return to the game, press <ENTER>.</p> <p>To edit the shot clock Reset 1 time, use the number pad to enter the new time in minutes and seconds, and then press <ENTER>.</p> <p>To discard the edited time, press <CLEAR> twice to clear the changes and return to the game.</p> <p>Note: The Reset 1 value is set in the EDIT SETTINGS menu.</p>

Display	Action
<div style="border: 1px solid black; padding: 5px; display: inline-block;"> SHOT CLOCK-EDIT RESET 2 MM:SS* </div> MM:SS = minutes, seconds	<p>Press <SET SHOT TIME •> three times to display the configured shot clock Reset 2 time.</p> <p>To accept the shot clock Reset 2 time and return to the game, press <ENTER>.</p> <p>To edit the shot clock Reset 2 time, use the number pad to enter the new time in minutes and seconds, and then press <ENTER>.</p> <p>To discard the edited time, press <CLEAR> twice to clear the changes and return to the game.</p> <p>Note: The Reset 2 value is set in the EDIT SETTINGS menu.</p>

Note: To blank the shot clock while keeping the rest of the scores and statistics visible: Press **<SET SHOT TIME>**, **<CLEAR>**, and then **<ENTER>**.

Recall Shot Time

Display	Action
<div style="border: 1px solid black; padding: 5px; display: inline-block;"> SHOT CLOCK-MODE RECALL Y/N </div>	<p>Press <RECALL SHOT TIME •> followed by <YES> to recall the shot time that was remaining before the last shot clock reset was pressed.</p> <p>To cancel the recall, press <NO>.</p>

Time Out On/Off

<TIME OUT ON/OFF> stops and starts the time out clock. The length of both the full and partial time outs can also be changed when the time out clock is stopped.

Note: Only the time outs configured in the **EDIT SETTINGS** menu are displayed on the LCD and available for selection.

Display	Action
<div style="border: 1px solid black; padding: 5px; display: inline-block;"> TIME OUTS-SELECT FULL MM:SS </div> MM:SS = minutes, seconds	<p>Press <TIME OUT ON/OFF> to display the configured time for full time out length. To start the full time out, press <ENTER>.</p> <p>To cancel the full time out, press <CLEAR>.</p>
<div style="border: 1px solid black; padding: 5px; display: inline-block;"> TIME OUTS-SELECT PARTIAL MM:SS </div> MM:SS = minutes, seconds	<p>Press <TIME OUT ON/OFF> two times to display the configured time for partial time out length. To start the partial time out, press <ENTER>.</p> <p>To cancel the partial time out, press <CLEAR>.</p>

Blank Player Foul

Press **<BLANK PLAYER FOUL>** to blank the digits of the Player-Foul field of the scoreboard.

Period +1

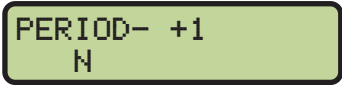
Display	Action
 <p>N = current setting</p>	<p>Press <PERIOD +1> to increment the period number.</p> <p>Note: The full and partial time outs and team fouls are automatically reset at halftime.</p>

Time Out

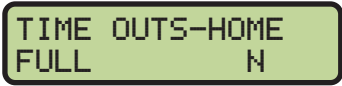
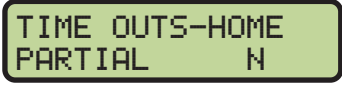
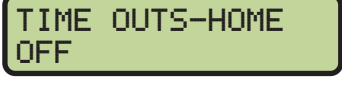
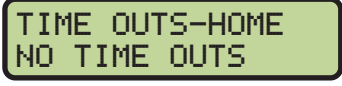

The home and guest **<TIME OUT>** keys are used to decrement the number of time outs remaining and start the time out clock. The scoreboard indicator is turned on when the type of time out is selected (full or partial). The scoreboard indicator is turned off when the time out clock expires or is stopped.

Note: Only the time outs configured in the **EDIT SETTINGS** menu are displayed on the LCD and available for selection.

Display	Action
 <p>N = current setting</p>	<p>Press <TIME OUT> to display the number of full time outs remaining. To accept the full time out and start the time out clock, press <ENTER>.</p> <p>To cancel the full time out, press <CLEAR>.</p>
 <p>N = current setting</p>	<p>Press <TIME OUT> two times to display the number of partial time outs remaining. To start the partial time out, press <ENTER>.</p> <p>To cancel the partial time out, press <CLEAR>.</p>
	<p>To exit the running time out clock, press <TIME OUT>. This will turn the time out OFF.</p>
	<p>This message appears when there are no full time outs or partial time outs remaining.</p>

Score (+1/+2/+3/-1)

The home and guest **<SCORE +1>**, **<SCORE +2>**, and **<SCORE +3>** keys are used to increment the team score and the **<SCORE -1>** key is used to decrement the team score.

Display	Action
 <p>NNN = current setting</p>	<p>Press the appropriate score key to increment or decrement the score for the home or guest team.</p> <p>The LCD shows which key was pressed and the new value for the team score of the corresponding team.</p>
 <p>NN = current setting</p>	<p>If the program is configured to update the player points, this prompt displays asking for a player number.</p> <p>Enter the jersey number of the player who scored the points, and then press <ENTER>.</p>

Display	Action
<pre>HOME PLAYER NN NOT FOUND, ADD?</pre> <p>NN = current setting</p>	<p>If the player is not in the roster, this prompt asks if the player should be added.</p> <p>Press <YES> to add the player to the roster and credit the points to that player.</p> <p>Press <NO> to decline the entry of the player number.</p>
<pre>HOME PLAYER NN ROSTER FULL</pre> <p>NN = current setting</p>	<p>This message displays when the answer to the previous prompt is YES and the roster is full.</p>
<pre>HOME PLAYER NN POINTS XX</pre> <p>NN = player number XX = player points</p>	<p>The player's jersey number and number of points display if the player was found in the game or correctly added to the roster.</p>

Team Fouls (+1/-1)

Display	Action
<pre>TEAM FOULS- +1 HOME NN</pre> <p>NN = current setting</p>	<p>Press the home or guest <TEAM FOULS +1> key to increment the number of team fouls for the corresponding team. The number of team fouls stop incrementing at the number of fouls configured for the 1-on-1 or 2-shot bonus.</p>
<pre>TEAM FOULS- +1 HOME PLAYER NN*</pre> <p>NN = current setting</p>	<p>If the program is configured to update the player fouls, this prompt displays asking for a player number.</p> <p>Enter the jersey number of the player who made the foul, and then press <ENTER>.</p>
<pre>HOME PLAYER NN NOT FOUND, ADD?</pre> <p>NN = current setting</p>	<p>If the player is not in the roster, this prompt asks if the player should be added.</p> <p>Press <YES> to add the player to the roster and credit the foul to that player.</p> <p>Press <NO> to decline the entry of the player number.</p>
<pre>HOME PLAYER NN ROSTER FULL</pre> <p>NN = current setting</p>	<p>This message displays when the answer to the previous prompt is YES and the roster is full.</p>
<pre>HOME PLAYER NN FOULS XX</pre> <p>NN = player number XX = player fouls</p>	<p>The player's jersey number and the number of fouls display if the player was found in the game or correctly added to the roster.</p> <p>Note: If a player number is not entered, the fouls will not be displayed.</p>

Bonus

Note: Only the types of bonuses that are configured in the **EDIT SETTINGS** menu are displayed on the LCD and available for selection.

Display	Action
HOME BONUS 1-ON-1	Press the home or guest <BONUS> key to turn on the 1-on-1 bonus indicator for that team.
HOME BONUS 2-SHOT	Press the home or guest <BONUS> key two times to turn on the 2-shot bonus indicator for that team.
HOME BONUS OFF	Press the <BONUS> key three times to turn off both indicators.

Possession

Display	Action
HOME POSSESSION ON	Press the home or guest <POSS> key to turn on the possession indicator for that team.
HOME POSSESSION OFF	To turn off the possession indicator, press the same <POSS> key a second time, or press the opposite <POSS> key once.

In Game/Out of Game

The **<IN GAME>** and **<OUT OF GAME>** keys are only functional when the Home or Guest **<PLAYER>** key has been pressed.

Delete Player

The **<DELETE PLAYER>** key is only functional when the Home or Guest **<PLAYER>** key has been pressed.

Player

Note: If player stats are being received from the Daktronics Scoring-Timing Interface (DSTI), the **PLAYER**, **IND SUB**, and **MASS SUB** keys will be disabled. The LCD displays the messages shown below when these keys are pressed. Refer to **ED-13009** for more information about DSTI.

Display	Action
STATS RECEIVED KEY DISABLED	The KEY DISABLED message will display for one second and then the EXIT STATS message will display and wait for a <YES> or <NO> key. If the <YES> key is pressed, the stats data will be saved in the console, and the console will exit stats mode until another stats packet is received. This will allow the operator to enter stats from the console if the connection to DSTI is lost.
EXIT STATS MODE Y/N?	



Display	Action
<p>HOME PLAYER NN*</p> <p>NN = current setting</p>	<p>When the home or guest <PLAYER •> key is pressed, this prompt asks the jersey number of the player to be edited.</p> <p>Enter the jersey number using the number pad, and then press <ENTER>.</p>
<p>HOME PLAYER NN NOT FOUND, ADD?</p> <p>NN = current setting</p>	<p>If the player is not in the roster, this prompt asks if the player should be added.</p> <p>Press <YES> to add the player to the roster.</p> <p>Press <NO> to decline the entry of the player number.</p>
<p>HOME PLAYER NN ROSTER FULL</p> <p>NN = current setting</p>	<p>This message displays when the answer to the previous prompt is YES and the roster is full.</p>
<p>HOME PLAYER NN S-I F-X* P-YY</p> <p>NN = player number</p> <p>S-I = in game S-O = out of game</p> <p>X = number of fouls YY = number of points</p>	<p>If the player is found, the player's game status and statistics can be changed by following the steps below.</p> <ol style="list-style-type: none"> 1. Use the up and down arrow keys to select the player from the list. 2. Press <IN GAME> or <OUT OF GAME>. The S field on the display changes to show the player's current status. 3. Use the left and right arrow keys to select the statistic to be changed. 4. Enter the correct value for the selected statistic using the number pad, and then press <ENTER>. <p>Press <CLEAR> to exit the menu and return to the game.</p>
<p>HOME PLAYER NN DELETE PLAYER?</p> <p>NN = current setting</p>	<p>To delete an incorrect player from the roster, use the up and down arrow keys to select the player from the list, and then press <DELETE PLAYER>.</p> <p>Press <YES> to remove the player from the roster.</p> <p>Press <NO> to decline the deletion and return to the game.</p>

Individual Substitution

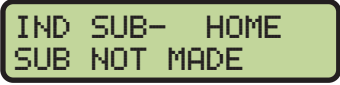
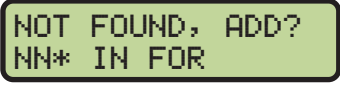
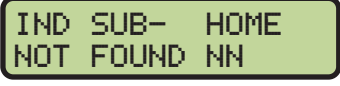
Display	Action
<p>IND SUB- HOME NN* IN FOR XX</p> <p>NN = sub player XX = in game player</p>	<p>When the home or guest <INDIV. SUB. •> key is pressed, this prompt asks the jersey number of the player entering and leaving the game.</p> <p>Enter the jersey number of the player entering the game using the number pad, and then press <ENTER>.</p> <p>Enter the jersey number of the player leaving the game using the number pad, and then press <ENTER>.</p>
<p>IND SUB- HOME SUB OK</p>	<p>This message is displayed if no errors are found.</p>

Display	Action
	<p>This message is displayed for the following reasons:</p> <ul style="list-style-type: none"> • The player going into the game is already marked as in. • The player coming out of the game is not marked as in.
 <p>NN = current setting</p>	<p>This message is displayed if the player going in the game is not found in the roster.</p> <p>Press <YES> to add the player to the roster.</p> <p>Otherwise, press <NO> followed by <INDIV. SUB. •> to try entering the sub again.</p>
 <p>NN = current setting</p>	<p>This message is displayed if the player going out of the game is not found in the roster.</p> <p>Press <INDIV. SUB. •> to try entering the sub again.</p>

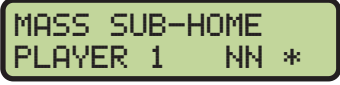
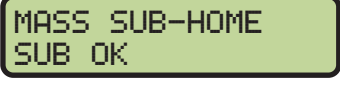
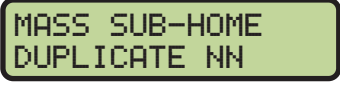
Mass Substitution

Display	Action
 <p>NN = current setting</p>	<p>After the home or guest <MASS SUB. •> key is pressed, the LCD will display a message asking for the first of five player numbers that are going into the game. Enter the jersey number using the number pad, and then press <ENTER> for each of the five players. Press <CLEAR> at any time to exit.</p>
	<p>This message is displayed if no errors are found.</p>
 <p>NN = current setting</p>	<p>This message displays for each duplicate jersey number found for the five players going into the game.</p> <p>Press <YES> to correct the jersey number. Enter the correct jersey number, and then press <ENTER>.</p>
 <p>NN = current setting</p>	<p>This message displays for each player not found in the roster.</p> <p>Press <YES> to add the jersey number. Press <NO> to ignore and select another jersey number.</p> <p>Enter the jersey number, and then press <ENTER>.</p>

Edit

Press **<EDIT>** followed by one of the keys below to quickly edit the value.

Time Out

Note: Only the time outs configured in the **EDIT SETTINGS** menu are displayed on the LCD and available for selection.

Display	Action
<div style="border: 1px solid black; padding: 5px; background-color: #d9ead3;"> TIME OUTS-HOME FULL N* </div> <p>N = current setting</p>	<p>Press <EDIT> followed by <TIME OUT> for the home or guest team to display the current setting of full time outs.</p> <p>Enter the correct full time outs value using the number pad, and then press <ENTER>.</p>
<div style="border: 1px solid black; padding: 5px; background-color: #d9ead3;"> TIME OUTS-HOME PARTIAL N* </div> <p>N = current setting</p>	<p>After accepting or rejecting the number of full time outs, the number of partial time outs is displayed.</p> <p>Enter the correct partial time outs value using the number pad, and then press <ENTER>.</p>

Score (+1/+2/+3/-1)

Display	Action
<div style="border: 1px solid black; padding: 5px; background-color: #d9ead3;"> TEAM SCORE- EDIT HOME NNN* </div> <p>NNN = current setting</p>	<p>Press <EDIT> and any of the SCORE keys for the home or guest team to display the current team score setting.</p> <p>Enter the correct team score value using the number pad, and then press <ENTER>.</p>

Team Fouls (+1/-1)

Display	Action
<div style="border: 1px solid black; padding: 5px; background-color: #d9ead3;"> TEAM FOULS- EDIT HOME N* </div> <p>N = current setting</p>	<p>Press <EDIT> followed by a <TEAM FOULS> key for the home or guest team to display the current team foul setting.</p> <p>Enter the correct team fouls value using the number pad, and then press <ENTER>.</p>

Period +1

Display	Action
<div style="border: 1px solid black; padding: 5px; background-color: #d9ead3;"> PERIOD- EDIT N* </div> <p>N = current setting</p>	<p>Press <EDIT> followed by <PERIOD +1> to display the current period setting.</p> <p>Enter the correct period value using the number pad, and then press <ENTER>.</p>

Time Out On/Off

Display	Action
<div style="border: 1px solid black; padding: 5px; background-color: #d9ead3;"> TIME OUTS-EDIT FULL MM:SS* </div> <p>MM:SS = minutes, seconds</p>	<p>Press <EDIT> followed by <TIME OUT ON/OFF> to display the current time setting for full time outs.</p> <p>Enter the correct full time out time value using the number pad, and then press <ENTER>.</p>
<div style="border: 1px solid black; padding: 5px; background-color: #d9ead3;"> TIME OUTS-EDIT PARTIAL MM:SS* </div> <p>MM:SS = minutes, seconds</p>	<p>After accepting or rejecting the full time outs time setting, the partial time outs time setting is displayed.</p> <p>Enter the correct partial time out time value using the number pad, and then press <ENTER>.</p>

Menu

Press **<MENU>** to access general and sport-specific options. Use the up and down arrow keys to scroll through the menu list. Press **<MENU>** again at any time to return to the game in progress.

New Game

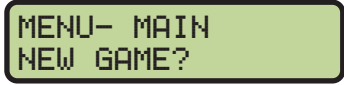
Display	Action
	Press <ENTER> to clear all data for the current game in progress and begin a new game.

New Code

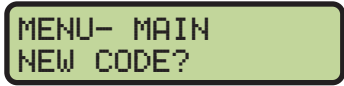

Display	Action
	Press <ENTER> to switch to a different sport code through the SELECT CODE prompt. Refer to Start Up (p. 6) for more information on sport codes.







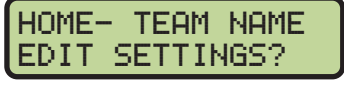
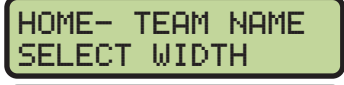
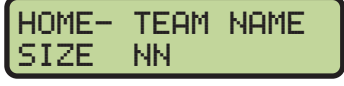

Dimming Menu

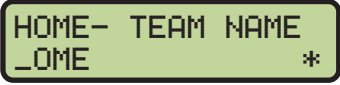
Refer to **Dimming Menu (p. 15)**.

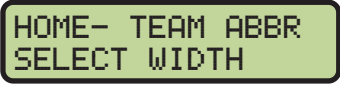
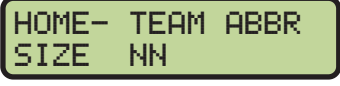
Home Roster, Guest Roster

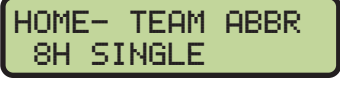
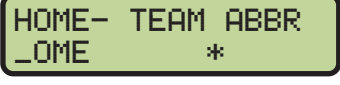
Use the **Home Roster** and **Guest Roster** menus to set up team names and other player information. **Home Roster** is used as an example below.

Display	Action
	Press <ENTER> to select the Roster submenu.
	Press <ENTER> to select the Team Name Edit Settings submenu.
	Press <ENTER> to select the width (in pixels) of the Team Name Message Centers (TNMC) used on the scoreboard.
 <p>NN = current setting</p>	Select from 16, 32, 48, or 64, and then press <ENTER> .
 	On the following menu, press <ENTER> and use the left/right arrows to select one of the following fonts for the team name: 8H SINGLE (single stroke), 8H BOLD (double stroke), 8H NARROW (single stroke, alternate narrow), or 8H NARROW BOLD (double stroke, alternate narrow) After selecting a font type, press <ENTER> .

Display	Action
	<p>Use the TEAM NAME (LL-2441) insert to change the Team Name Message Center (TNMC) settings.</p> <p>Type in a team name of up to 15 characters and press <ENTER>.</p> <p>Refer to Team Name Entry (p. 19) for more information.</p>
   <p>NN = current setting</p>	<p>Press <ENTER> to select the Team Abbreviation Edit Settings submenu.</p> <p>Press <ENTER> to select the width (in pixels) of the Team Name Message Centers (TNMC) used on the scoreboard.</p> <p>Select from 16, 32, 48, or 64, and then press <ENTER>.</p>
 	<p>On the following menu, press <ENTER> and use the left/right arrows to select one of the following fonts for the team name: 8H SINGLE (single stroke), 8H BOLD (double stroke), 8H NARROW (single stroke, alternate narrow), or 8H NARROW BOLD (double stroke, alternate narrow)</p> <p>After selecting a font type, press <ENTER>.</p>
	<p>Type in a team abbreviation of up to 10 characters and press <ENTER>.</p> <p>Reinsert the BASKETBALL (LL-2433) insert to continue.</p>
  <p>NN = current setting</p>	<p>Press <YES> to assign jersey numbers for all players in the roster.</p> <p>Press <NO> to exit the submenu and return to the Main menu.</p> <p>Once EDIT PLAYERS is selected, enter the jersey number for that player from the official roster and press <ENTER>. The next player is shown on the LCD. Continue entering the jersey numbers for up to 15 players.</p> <p>Press <CLEAR> to advance to the next option.</p>
	<p>This function clears all game statistics and should only be used before the start of a game.</p> <p>Press <YES> to clear the stats for all players in the team's roster.</p> <p>Press <NO> to cancel clearing the stats.</p>

Display Menu

Refer to **Display Menu (p. 15)** for more information.

Color Menu

Refer to **Color Menu (p. 16)** for more information.

Time of Day

Refer to **Time of Day (p. 17)** for more information.

Edit Settings

Display	Action
	From the Main Menu, select the EDIT SETTINGS submenu to modify the settings below.

Number of Periods

Display	Action
<p>N = current setting</p>	<p>The Number of Periods setting indicates whether the game consists of two halves or four quarters.</p> <p>Press <2> or <4> on the number pad to select the desired number of periods.</p>





Main Clock

The settings for the Main Clock are used with the **<SET MAIN CLOCK>** key.

The period, break, and overtime lengths are used differently depending on the direction of the main clock. For count down, the main clock is set to the selected length, decrements towards zero, and stops at zero. For count up, the main clock is set to zero, increments towards the selected length, and stops when the selected length is reached.

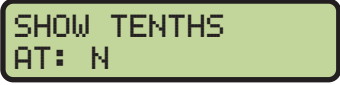
Display	Action
	<p>When the main clock is set to count down and tenths of a second is selected, the main clock displays in tenths of a second remaining when the time is below one minute.</p> <p>Press <YES> to set the main clock to display tenths of a second. Press <NO> to display whole seconds.</p>
<p>MM:SS = minutes, seconds</p>	<p>Enter the correct amount of time per period in minutes and seconds using the number pad, and then press <ENTER>.</p> <p>Note: Pressing <ENTER> to select the period time as the main clock setting will increment the current period number if the clock value was previously zero.</p>
<p>MM:SS = minutes, seconds</p>	<p>Set the amount of time between periods.</p> <p>Enter the correct amount of time for break length in minutes and seconds using the number pad, and then press <ENTER>.</p>
<p>MM:SS = minutes, seconds</p>	<p>Set the amount of time for the overtime periods.</p> <p>Enter the correct amount of time for overtime periods in minutes and seconds using the number pad, and then press <ENTER>.</p>

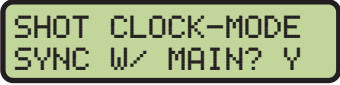
Shot Clock

Display	Action
  N = current setting	<p>This setting allows a shot clock to display tenths of a second.</p> <p>Press <YES> to set ON, or press <NO> to set OFF.</p> <p>If YES is selected, a prompt will ask to enter a value for when to show the tenths. The tenths digit and a period will display when the shot time is below the set value. Enter a value of <0> to <9> and press <ENTER> (use "0" for 10 seconds).</p>
  MM:SS = minutes, seconds	<p>This setting is used for the <RESET> button on the remote shot clock control console.</p> <p>Note: The current setting for the <RESET> time displays on the LCD until the first number key is pressed.</p> <p>Enter the correct amount of reset time in minutes and seconds using the number pad, and then press <ENTER>.</p>
	<p>Press <YES> to synchronize the shot clock with the main clock. If <STOP> for the main clock is pressed while the main and shot clocks are running, the shot clock also stops. The shot clock restarts when <START> is pressed for the main clock.</p> <p>Press <NO> to allow the shot clock to run independently of the main clock. The shot clock starts and stops only with the switch on the remote shot clock control console.</p>
	<p>Press <YES> to blank the shot clock time when the shot clock time is greater than or equal to the main clock time. The shot clock is reset and stopped when the display is blanked to eliminate inadvertent sounding of shot clock horn.</p> <p>Press <NO> to display the shot clock time at all times.</p>



Time Outs

If a full or partial time out is not needed for the HOME or GUEST **<TIME OUT>** keys, enter zero for the number of time outs.

If a full or partial time out is not needed for **<TIME OUT ON/OFF>**, enter zero for the time.

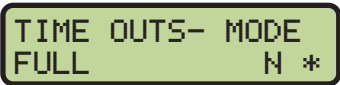
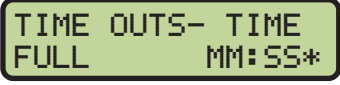
The number for each type of time out must be manually entered for an overtime period using the **<EDIT>** **<TIME OUT>** key sequence for each team.

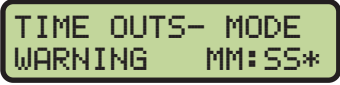
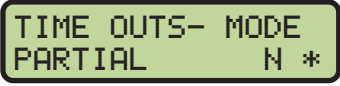
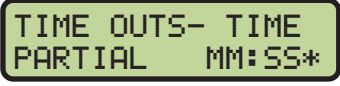
Display	Action
 N = current setting	<p>Enter the number of full time outs using the number pad, and then press <ENTER>.</p>
 MM:SS = minutes, seconds	<p>Enter the amount of time for a full time out in minutes and seconds using the number pad, and then press <ENTER>.</p>

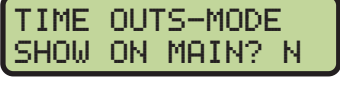
Display	Action
 <p>MM:SS = minutes, seconds</p>	<p>A warning horn can be configured to signal the end of a full time out. While the time out clock is counting down, the horn will sound for one second when the warning time is reached. Enter a zero for the time to disable the warning horn.</p> <p>Enter the time in minutes and seconds using the number pad, and then press <ENTER>.</p>
 <p>N = current setting</p>	<p>Enter the number of partial time outs using the number pad, and then press <ENTER>.</p>
 <p>MM:SS = minutes, seconds</p>	<p>Enter the amount of time for a partial time out in minutes and seconds using the number pad, and then press <ENTER>.</p>
 <p>MM:SS = minutes, seconds</p>	<p>A warning horn can be configured to signal the end of a partial time out. While the time out clock is counting down, the horn will sound for one second when the warning time is reached. Enter a zero for the time to disable the warning horn.</p> <p>Enter the time in minutes and seconds using the number pad, and then press <ENTER>.</p>
	<p>Press <YES> to display the time out time on the LCD and the clock digits of the scoreboard while the time out clock is active, or press <NO> to display the time out time on the LCD only.</p>

Team Score

Display	Action
	<p>This feature must be enabled for statistics displays.</p> <p>Press <YES> to allow entry of a player number after the home or guest team scores are incremented or decremented.</p> <p>Press <NO> to prevent entry of a player number.</p>

Team Fouls

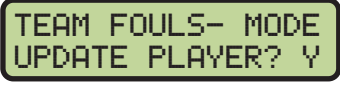
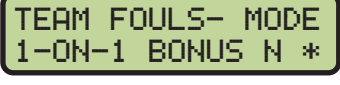
Display	Action
	<p>This feature must be enabled for statistics displays.</p> <p>Press <YES> to allow entry of a player number after the home or guest team fouls are incremented or decremented.</p> <p>Press <NO> to prevent entry of a player number.</p>
 <p>N = current setting</p>	<p>Enter the number of team fouls permitted before the 1-on-1 bonus applies, and then press <ENTER>. The home and guest team fouls stop incrementing at this number unless the 2-shot bonus is enabled. Enter zero to disable this feature.</p>

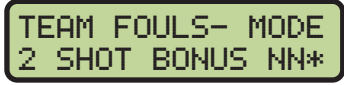
Display	Action
 <p>NN = current setting</p>	<p>Enter the number of team fouls permitted before the 2-shot bonus applies, and then press <ENTER>.</p> <p>Enter zero to disable this feature.</p>

Select Captions

Display	Action
	<p>This menu option allows for the controlled backlit captions to be turned ON/OFF.</p> <p>Press the <1> key to select ON and OFF for captions controlled by control #1.</p> <p>Press the <2> key to select ON and OFF for captions controlled by control #2.</p>

Select Team Foul Display

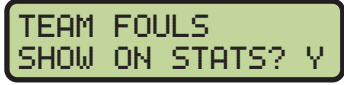
Display	Action
	<p>This menu option selects whether or not to show team fouls on line 6 of player stats panels.</p> <p>To display team fouls, press <YES>. To not display team fouls, press <NO>.</p>

Score by Quarter

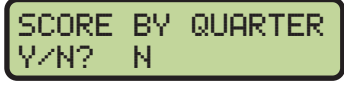
Display	Action
	<p>This feature allows for scores to be recorded by quarter. This data is available on the RTD output.</p> <p>Press <YES> to score by quarter, or press <NO> to not score by quarter.</p> <p>Note: If this feature is enabled, all scores are edited by quarter. Use this function only when needed.</p>

Shot Horn Control

Display	Action
	<p>This menu option allows the selection of what will control the output for the shot clock horn. Use the left or right arrow keys to scroll to the desired setting, or use the <0> – <3> number keys.</p> <p>Press <ENTER> when the desired setting is shown.</p> <p>0 = NO CONTROL, 1 = MAIN HORN, 2 = SHOT HORN, 3 = MAIN & SHOT</p>

Light Control

Display	Action
	<p>This menu option allows the selection of what will control the output for the light strip displays. Use the left or right arrow keys to scroll to the desired setting, or use the <1> – <6> number keys.</p> <p>Press <ENTER> when the desired setting is shown.</p> <p>1 = CLK=0, 2 = CLK STOP, 3 = (not used), 4 = MAIN HORN, 5 = CLK=0 & HRN, 6 = STOP & HRN</p>

Switch Output

Refer to **Switch Output (p. 18)** for more information.

Default Settings

Print this page if necessary, and record any custom settings for this installation:

Setting	Default	Custom 1	Custom 2	Custom 3	Custom 4
Number of Periods	4				
Tenth of a Second	Yes				
Period Length	8:00				
Break Length	10:00				
Overtime Length	5:00				
Pre-Game Length	20:00				
Post-Game Length	30:00				
Shot Clock Tenth Sec.	No				
Shot Clock Reset 1	0:45				
Shot Clock Reset 2	0:30				
Sync Shot with Main	Yes				
Shot Clock Auto Blank	Yes				
Full Time Outs	3				
Full Time Out	1:00				
Time Out Warning	0:00				
Partial Time Outs	2				
Partial Time Out	00:20				
Partial Time Out Warn	0:00				
Show on Main	No				
Update Player Score	No				
Update Player Fouls	Yes				
1-on-1 Bonus	7				
2-Shot Bonus	10				
Select Captions	1-ON				
Show Fouls on Stats	No				
Score by Quarter	No				
Shot Horn Control	Main Horn				
Light Control	Clk=0				
Switch Output	1-Clock = 0				

5 Volleyball Operation

Sport Insert: LL-2434

The Sport and Team Name Insert drawings are located in **Appendix B**. The Block Diagram drawings are located in **Appendix A**. The Quick Reference is located in **Appendix D**.

Reference Drawings:

- Block Diagram: AS5000 BB- VB and WR #1 **DWG-124686**
- Block Diagram: AS5000 BB- VB and WR #3..... **DWG-124688**
- Insert; LL-2434 A/S 5000, Volleyball **DWG-125055**
- Insert; LL-2441 A/S 5000, Team Name **DWG-125290**
- Block Diagram- A/S 3000 or 5000 BB- VB and WR #2 **DWG-125415**

Refer to the information in **Section 2: Basic Operation (p. 4)** to start up the console and how to use the sport insert.

If an insert is lost/damaged, use a copy of the insert drawing until a replacement arrives.

Use the label sheet provided with the console (Daktronics part # LL-2458) to attach the correct code number label to the sport insert in the designated location. Write the code number in the space below. If viewing a digital copy of this manual, print this page and fill in the code number.

Write the correct code number here:

If the code number for a scoreboard is unknown, refer to **Appendix C**. If the scoreboard model number is unknown, refer to the documentation provided with the scoreboard.

Volleyball Keys

Time Out On/Off

<TIME OUT ON/OFF> stops and starts the time out clock. The length of both the full and partial time outs can also be changed when the time out clock is stopped.

Note: Only the time outs configured in the **EDIT SETTINGS** menu are displayed on the LCD and available for selection.

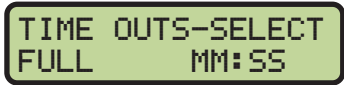
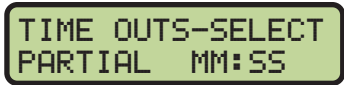
Display	Action
 MM:SS = minutes, seconds	Press <TIME OUT ON/OFF> to display the configured time for full time out length. To start the full time out, press <ENTER> . To cancel the full time out, press <CLEAR> .
 MM:SS = minutes, seconds	Press <TIME OUT ON/OFF> two times to display the configured time for partial time out length. To start the partial time out, press <ENTER> . To cancel the partial time out, press <CLEAR> .

Time Out

The home and guest **<TIME OUT>** keys are used to decrement the number of time outs remaining and start the time out clock. The scoreboard indicator is turned on when the type of time out is selected (full or partial). The scoreboard indicator is turned off when the time out clock expires or is stopped.

Note: Only the time outs configured in the **EDIT SETTINGS** menu are displayed on the LCD and available for selection.

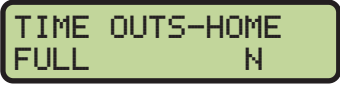
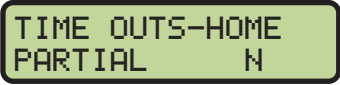
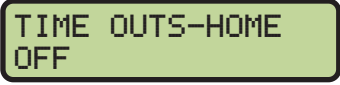
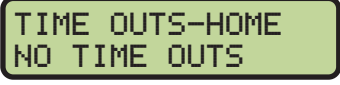
Display	Action
 <p>N = current setting</p>	<p>Press <TIME OUT> to display the number of full time outs remaining. To accept the full time out and start the time out clock, press <ENTER>.</p> <p>To cancel the full time out, press <CLEAR>.</p>
 <p>N = current setting</p>	<p>Press <TIME OUT> two times to display the number of partial time outs remaining. To start the partial time out, press <ENTER>.</p> <p>To cancel the partial time out, press <CLEAR>.</p>
	<p>To exit the running time out clock, press <TIME OUT>. This will turn the time out OFF.</p>
	<p>This message appears when there are no full time outs or partial time outs remaining.</p>

Match Number +1, Sets +1

The **<MATCH NUMBER +1>** and **<SETS +1>** keys are both used to increment their respective totals. **<SETS +1>** is used as an example below.

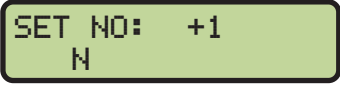
Display	Action
 <p>N = current setting</p>	<p>Press the appropriate key to increment statistics for the home or guest team.</p> <p>The LCD shows which key was pressed and the new value for the corresponding team.</p>

Score (+1/-1)

The home and guest **<SCORE +1>** and **<SCORE -1>** keys are used to increment and decrement the team score.

Display	Action
 <p>NN = current setting</p>	<p>Press the appropriate score key to increment or decrement the score for the home or guest team.</p> <p>The LCD shows which key was pressed and the new value for the team score of the corresponding team.</p>





Sets Won +1, Subs +1

The <**SETS WON +1**> and <**SUBS +1**> keys are both used to increment their respective totals. <**SETS WON +1**> is used as an example below.

Display	Action
 <p>SETS WON: +1 HOME NN</p> <p>NN = current setting</p>	<p>Press the appropriate key to increment statistics for the home or guest team.</p> <p>The LCD shows which key was pressed and the new value for the corresponding team.</p>

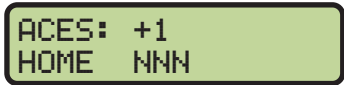
Aces +1, Kills +1, Blocks +1, Digs +1

The home and guest <**ACES +1**>, <**KILLS +1**>, <**BLOCKS +1**>, and <**DIGS +1**> keys are all used to increment their respective totals. <**ACES +1**> is used as an example below.

Display	Action
 <p>ACES: +1 HOME NNN</p> <p>NNN = current setting</p>	<p>Press the appropriate key to increment statistics for the home or guest team.</p> <p>The LCD shows which key was pressed and the new value for the corresponding team.</p>
 <p>ACES: +1 HOME PLAYER NN*</p> <p>NN = current setting</p>	<p>If the program is configured to update the player stats, this prompt displays asking for a player number.</p> <p>Enter the jersey number of the player who made the play using the number pad, and then press <ENTER>.</p>
 <p>HOME PLAYER NN NOT FOUND, ADD?</p> <p>NN = current setting</p>	<p>If the player is not in the roster, this prompt asks if the player should be added.</p> <p>Press <YES> to add the player to the roster and credit the play to that player.</p> <p>Press <NO> to decline the entry of the player number.</p>
 <p>HOME PLAYER NN ROSTER FULL</p> <p>NN = current setting</p>	<p>This message displays when the answer to the previous prompt is <YES> and the roster is full.</p>
 <p>HOME PLAYER NN ACES XX</p> <p>NN = player number XX = current stat value</p>	<p>The player's jersey number and stats display if the player was found in the game or correctly added to the roster.</p>

Serve

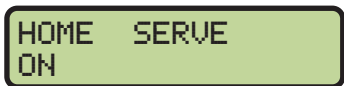
Display	Action
 <p>HOME SERVE ON</p>	<p>Press the home or guest <SERVE> key to turn on the indicator for that team.</p>

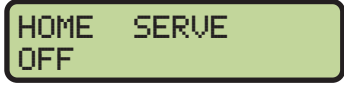
Display	Action
	To turn off the indicator, press the same <SERVE> key a second time, or press the opposite <SERVE> key once.

In Game/Out of Game





The **<IN GAME>** and **<OUT OF GAME>** keys are only functional when the Home or Guest **<PLAYER>** key has been pressed.

Delete Player

The **<DELETE PLAYER>** key is only functional when the Home or Guest **<PLAYER>** key has been pressed.

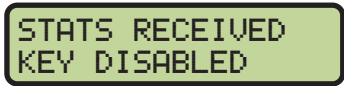
Player

Note: If player stats are being received from the Daktronics Scoring-Timing Interface (DSTI), the PLAYER, IND SUB, and MASS SUB keys will be disabled. The LCD displays the messages shown below when these keys are pressed. Refer to **ED-13009** for more information about DSTI.

Display	Action
 	The KEY DISABLED message will display for one second and then the EXIT STATS message will display and wait for a <YES> or <NO> key. If the <YES> key is pressed, the stats data will be saved in the console, and the console will exit stats mode until another stats packet is received. This will allow the operator to enter stats from the console if the connection to DSTI is lost.
 NN = current setting	When the home or guest <PLAYER •> key is pressed, this prompt asks the jersey number of the player to be edited. Enter the jersey number using the number pad, and then press <ENTER> .
 NN = current setting	If the player is not in the roster, this prompt asks if the player should be added. Press <YES> to add the player to the roster. Press <NO> to decline the entry of the player number.
 NN = current setting	This message displays when the answer to the previous prompt is YES and the roster is full.



Display	Action
<pre>HOME PLAYER NN S-I A-XX* K-YY</pre> <p>NN = player number S-I = in game S-O = out of game</p> <p>XX = number of aces YY = number of kills</p>	<p>If the player is found, the player's game status and statistics can be changed by following the steps below.</p> <ol style="list-style-type: none"> 1. Use the up and down arrow keys to select the player from the list. 2. Press <IN GAME> or <OUT OF GAME>. The S field on the display changes to show the player's current status. 3. Use the left and right arrow keys to select the statistic to be changed. The display shifts to show all of the statistic fields. 4. Enter the correct value for the selected statistic using the number pad, and then press <ENTER>. <p>Press <CLEAR> to exit the menu and return to the game.</p>
<pre>HOME PLAYER NN S-I B-XX* D-YY</pre> <p>XX = number of blocks YY = number of digs</p>	
<pre>HOME PLAYER NN DELETE PLAYER?</pre> <p>NN = current setting</p>	<p>To delete an incorrect player from the roster, use the up and down arrow keys to select the player from the list, and then press <DELETE PLAYER>.</p> <p>Press <YES> to remove the player from the roster.</p> <p>Press <NO> to decline the deletion and return to the game.</p>

Individual Substitution

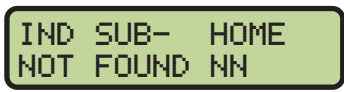
Display	Action
<pre>IND SUB- HOME NN* IN FOR XX</pre> <p>NN = sub player XX = in game player</p>	<p>When the home or guest <INDIV. SUB. •> key is pressed, this prompt asks the jersey number of the player entering and leaving the game.</p> <p>Enter the jersey number of the player entering the game using the number pad, and then press <ENTER>.</p> <p>Enter the jersey number of the player leaving the game using the number pad, and then press <ENTER>.</p>
<pre>IND SUB- HOME SUB OK</pre>	<p>This message is displayed if no errors are found.</p>
<pre>IND SUB- HOME SUB NOT MADE</pre>	<p>This message is displayed for the following reasons:</p> <ul style="list-style-type: none"> • The player going into the game is already marked as in. • The player coming out of the game is not marked as in.
<pre>NOT FOUND, ADD? NN* IN FOR</pre> <p>NN = current setting</p>	<p>This message is displayed if the player going in the game is not found in the roster.</p> <p>Press <YES> to add the player to the roster.</p> <p>Otherwise, press <NO> followed by <INDIV. SUB. •> to try entering the sub again.</p>

Display	Action
 <p>NN = current setting</p>	<p>This message is displayed if the player going out of the game is not found in the roster.</p> <p>Press <INDIV. SUB. •> to try entering the sub again.</p>

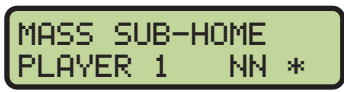
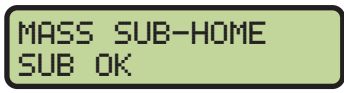
Mass Substitution

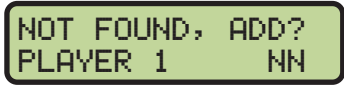
Display	Action
 <p>NN = current setting</p>	<p>After the home or guest <MASS SUB. •> key is pressed, the LCD will display a message asking for the first of five player numbers that are going into the game. Enter the jersey number using the number pad, and then press <ENTER> for each of the five players. Press <CLEAR> at any time to exit.</p>
	<p>This message is displayed if no errors are found.</p>
 <p>NN = current setting</p>	<p>This message displays for each duplicate jersey number found for the five players going into the game.</p> <p>Press <YES> to correct the jersey number. Enter the correct jersey number, and then press <ENTER>.</p>
 <p>NN = current setting</p>	<p>This message displays for each player not found in the roster.</p> <p>Press <YES> to add the jersey number. Press <NO> to ignore and select another jersey number.</p> <p>Enter the jersey number, and then press <ENTER>.</p>

Edit

Press <EDIT> followed by one of the keys below to quickly edit the value.

Time Out

Note: Only the time outs configured in the **EDIT SETTINGS** menu are displayed on the LCD and available for selection.

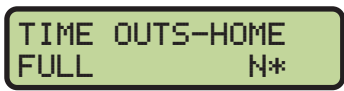
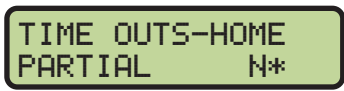
Display	Action
 <p>N = current setting</p>	<p>Press <EDIT> followed by <TIME OUT> for the home or guest team to display the current setting of full time outs.</p> <p>Enter the correct full time outs value using the number pad, and then press <ENTER>.</p>
 <p>N = current setting</p>	<p>After accepting or rejecting the number of full time outs, the number of partial time outs is displayed.</p> <p>Enter the correct partial time outs value using the number pad, and then press <ENTER>.</p>

Score (+1/-1)

Display	Action
 <p>TEAM SCORE: EDIT HM CURR: NNN*</p> <p>NNN = current setting</p>	<p>Press <EDIT> and either of the SCORE keys for the home or guest team to display the current team score setting.</p> <p>Enter the correct team score value using the number pad, and then press <ENTER>.</p>

Match Number +1, Sets +1

The **<MATCH NUMBER +1>** and **<SETS +1>** keys are both edited in the same way. **<SETS +1>** is used as an example below.

Display	Action
 <p>SET NO: EDIT N*</p> <p>N = current setting</p>	<p>Press <EDIT> followed by the appropriate statistic key to display the current setting.</p> <p>Enter the correct value using the number pad, and then press <ENTER>.</p>

Sets Won +1, Subs +1

The home and guest **<SETS WON +1>** and **<SUBS +1>** keys are both edited in the same way. **<SETS WON +1>** is used as an example below.

Display	Action
 <p>SETS WON: EDIT HOME NN*</p> <p>NN = current setting</p>	<p>Press <EDIT> followed by the appropriate statistic key to display the current setting.</p> <p>Enter the correct value using the number pad, and then press <ENTER>.</p>

Aces +1, Kills +1, Blocks +1, Digs +1

The home and guest **<ACES +1>**, **<KILLS +1>**, **<BLOCKS +1>**, and **<DIGS +1>** keys are all edited in the same way. **<ACES +1>** is used as an example below.

Display	Action
 <p>ACES: EDIT HOME NNN*</p> <p>NNN = current setting</p>	<p>Press <EDIT> followed by the appropriate statistic key to display the current setting.</p> <p>Enter the correct value using the number pad, and then press <ENTER>.</p>

Time Out On/Off

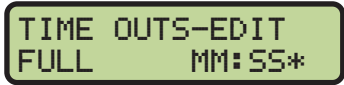
Display	Action
 <p>TIME OUTS-EDIT FULL MM:SS*</p> <p>MM:SS = minutes, seconds</p>	<p>Press <EDIT> followed by <TIME OUT ON/OFF> to display the current time setting for full time outs.</p> <p>Enter the correct full time out time value using the number pad, and then press <ENTER>.</p>

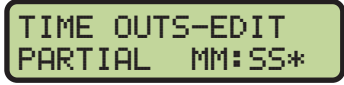
Display	Action
 <p>MM:SS = minutes, seconds</p>	<p>After accepting or rejecting the full time outs time setting, the partial time outs time setting is displayed.</p> <p>Enter the correct partial time out time value using the number pad, and then press <ENTER>.</p>

Menu

Press **<MENU>** to access general and sport-specific options. Use the up and down arrow keys to scroll through the menu list. Press **<MENU>** again at any time to return to the game in progress.

New Game

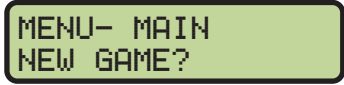
Display	Action
	<p>Press <ENTER> to clear all data for the current game in progress and begin a new game.</p>

New Code

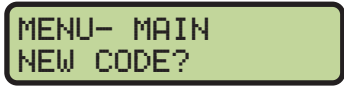
Display	Action
	<p>Press <ENTER> to switch to a different sport code through the SELECT CODE prompt. Refer to Start Up (p. 6) for more information on sport codes.</p>





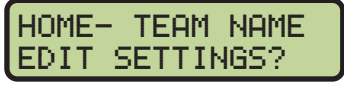
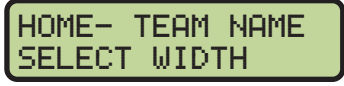
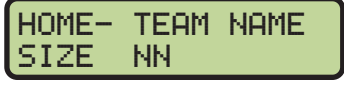

Dimming Menu

Refer to **Dimming Menu (p. 15)**.

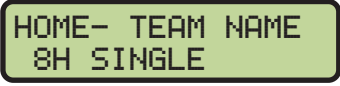
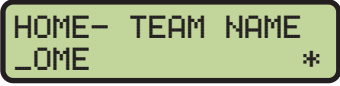
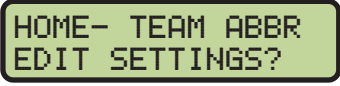
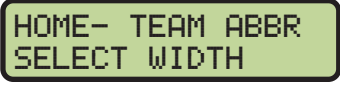
Home Roster, Guest Roster

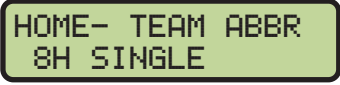
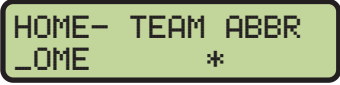
Use the **Home Roster** and **Guest Roster** menus to set up team names and other player information. **Home Roster** is used as an example below.

Display	Action
	<p>Press <ENTER> to select the Roster submenu.</p>
	<p>Press <ENTER> to select the Team Name Edit Settings submenu.</p>
	<p>Press <ENTER> to select the width (in pixels) of the Team Name Message Centers (TNMC) used on the scoreboard.</p>
 <p>NN = current setting</p>	<p>Select from 16, 32, 48, or 64, and then press <ENTER>.</p>

Display	Action
 	<p>On the following menu, press <ENTER> and use the left/right arrows to select one of the following fonts for the team name: 8H SINGLE (single stroke), 8H BOLD (double stroke), 8H NARROW (single stroke, alternate narrow), or 8H NARROW BOLD (double stroke, alternate narrow)</p> <p>After selecting a font type, press <ENTER>.</p>
	<p>Use the TEAM NAME (LL-2441) insert to change the Team Name Message Center (TNMC) settings.</p> <p>Type in a team name of up to 15 characters and press <ENTER>.</p> <p>Refer to Team Name Entry (p. 19) for more information.</p>
   <p>NN = current setting</p>	<p>Press <ENTER> to select the Team Abbreviation Edit Settings submenu.</p> <p>Press <ENTER> to select the width (in pixels) of the Team Name Message Centers (TNMC) used on the scoreboard.</p> <p>Select from 16, 32, 48, or 64, and then press <ENTER>.</p>
 	<p>On the following menu, press <ENTER> and use the left/right arrows to select one of the following fonts for the team name: 8H SINGLE (single stroke), 8H BOLD (double stroke), 8H NARROW (single stroke, alternate narrow), or 8H NARROW BOLD (double stroke, alternate narrow)</p> <p>After selecting a font type, press <ENTER>.</p>
	<p>Type in a team abbreviation of up to 10 characters and press <ENTER>.</p> <p>Reinsert the VOLLEYBALL (LL-2434) insert to continue.</p>
  <p>NN = current setting</p>	<p>Press <YES> to assign jersey numbers for all players in the roster.</p> <p>Press <NO> to exit the submenu and return to the Main menu.</p> <p>Once EDIT PLAYERS is selected, enter the jersey number for that player from the official roster and press <ENTER>. The next player is shown on the LCD. Continue entering the jersey numbers for up to 15 players.</p> <p>Press <CLEAR> to advance to the next option.</p>
	<p>This function clears all game statistics and should only be used before the start of a game.</p> <p>Press <YES> to clear the stats for all players in the team's roster.</p> <p>Press <NO> to cancel clearing the stats.</p>

Display Menu

Refer to **Display Menu (p. 15)** for more information.

Color Menu

Refer to **Color Menu (p. 16)** for more information.

Time of Day

Refer to **Time of Day (p. 17)** for more information.

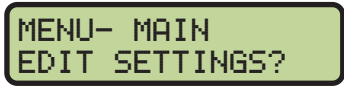

Edit Settings

Display	Action
	From the Main Menu, select the EDIT SETTINGS submenu to modify the settings below.

Main Clock

The settings for the Main Clock are used with the **<SET MAIN CLOCK>** key.

The period and break lengths are used differently depending on the direction of the main clock. For count down, the main clock is set to the selected length, decrements towards zero, and stops at zero. For count up, the main clock is set to zero, increments towards the selected length, and stops when the selected length is reached.

Display	Action
	When the main clock is set to count down and tenths of a second is selected, the main clock displays in tenths of a second remaining when the time is below one minute. Press <YES> to set the main clock to display tenths of a second. Press <NO> to display whole seconds.
 MM:SS = minutes, seconds	Enter the correct amount of time per period in minutes and seconds using the number pad, and then press <ENTER> . Note: Pressing <ENTER> to select the period time as the main clock setting will increment the current period number if the clock value was previously zero.
 MM:SS = minutes, seconds	Set the amount of time between periods. Enter the correct amount of time for break length in minutes and seconds using the number pad, and then press <ENTER> .

Time Outs

If a full or partial time out is not needed for the HOME or GUEST **<TIME OUT>** keys, enter zero for the number of time outs.

If a full or partial time out is not needed for **<TIME OUT ON/OFF>**, enter zero for the time.

Display	Action
<p>N = current setting</p>	Enter the number of full time outs using the number pad, and then press <ENTER> .
<p>MM:SS = minutes, seconds</p>	Enter the amount of time for a full time out in minutes and seconds using the number pad, and then press <ENTER> .
<p>MM:SS = minutes, seconds</p>	<p>A warning horn can be configured to signal the end of a full time out. While the time out clock is counting down, the horn will sound for one second when the warning time is reached. Enter a zero for the time to disable the warning horn.</p> <p>Enter the time in minutes and seconds using the number pad, and then press <ENTER>.</p>
<p>N = current setting</p>	Enter the number of partial time outs using the number pad, and then press <ENTER> .
<p>MM:SS = minutes, seconds</p>	Enter the amount of time for a partial time out in minutes and seconds using the number pad, and then press <ENTER> .
	Press <YES> to display the time out time on the LCD and the clock digits of the scoreboard while the time out clock is active, or press <NO> to display the time out time on the LCD only.

Team Stats

Display	Action
	<p>This feature must be enabled for statistics displays.</p> <p>Press <YES> to allow entry of a player number after the home or guest team aces, kills, blocks, or digs are incremented or decremented. Press <NO> to prevent entry of a player number.</p>

User Def 1 & User Def 2

User Def 1 and **User Def 2** are used to define which statistics (aces, kills, blocks, or digs) are shown on the statistic displays. Only two of the four statistics can be selected for display at any given time.

- **User Def 1** displays the statistics in the Foul digits.
- **User Def 2** displays the statistics in the Points digits.

User Def 1 and **User Def 2** are entered in the same way. **User Def 1** is used as an example.

Display	Action
<pre>USER DEF 1=N 1-ACES</pre>	<ul style="list-style-type: none"> • Press <1> or use the left/right arrow keys to scroll to ACES. • Press <2> or use the left/right arrow keys to scroll to KILLS. • Press <3> or use the left/right arrow keys to scroll to BLOCKS. • Press <4> or use the left/right arrow keys to scroll to DIGS. <p>Press <ENTER> to display the selected stat on the scoreboard.</p> <p>Press <CLEAR> to cancel and return to the game.</p>
<pre>USER DEF 1=N 2-KILLS</pre>	
<pre>USER DEF 1=N 3-BLOCKS</pre>	
<pre>USER DEF 1=N 4-DIGS</pre>	
N = current setting	

Select Captions

Display	Action
<pre>SELECT CAPTIONS ON 1←- → 2 OFF</pre>	<p>This menu option allows for the controlled backlit captions to be turned ON/OFF.</p> <p>Press the <1> key to select ON and OFF for captions controlled by control #1.</p> <p>Press the <2> key to select ON and OFF for captions controlled by control #2.</p>

Shot Horn Control

Display	Action
<pre>SHOT HRN CONTROL SET= SHOT HORN</pre>	<p>This menu option allows the selection of what will control the output for the shot clock horn. Use the left or right arrow keys to scroll to the desired setting, or use the <0> – <3> number keys.</p> <p>Press <ENTER> when the desired setting is shown.</p> <p>0 = NO CONTROL, 1 = MAIN HORN, 2 = SHOT HORN, 3 = MAIN & SHOT</p>

Light Control

Display	Action
<pre>LIGHT CONTROL SET= CLK=0</pre>	<p>This menu option allows the selection of what will control the output for the light strip displays. Use the left or right arrow keys to scroll to the desired setting, or use the <1> – <6> number keys.</p> <p>Press <ENTER> when the desired setting is shown.</p> <p>1 = CLK=0, 2 = CLK STOP, 3 = (not used), 4 = MAIN HORN, 5 = CLK=0 & HRN, 6 = STOP & HRN</p>

Switch Output

Refer to **Switch Output (p. 18)** for more information.

Default Settings

Print this page if necessary, and record any custom settings for this installation:

Setting	Default	Custom 1	Custom 2	Custom 3	Custom 4
Tenth of a Second	No				
Period Length	60:00				
Break Length	3:00				
Pre-Game Length	20:00				
Post-Game Length	30:00				
Full Time Outs	2				
Full Time Out	0:30				
Time Out Warning	0:00				
Partial Time Outs	0				
Partial Time Out	0:00				
User Def 1	Aces				
User Def 2	Kills				
Update Player	No				
Select Captions	1-ON				
Shot Horn Control	Main Horn				
Light Control	Clk=0				
Switch Output	1-Clock = 0				

6 Wrestling Operation

Sport Insert: LL-2435

The Sport and Team Name Insert drawings are located in **Appendix B**. The Block Diagram drawings are located in **Appendix A**. The Quick Reference is located in **Appendix D**.

Reference Drawings:

Block Diagram: AS5000 BB- VB and WR #1	DWG-124686
Block Diagram: AS5000 BB- VB and WR #3.....	DWG-124688
Insert; LL-2435 A/S 5000, Wrestling.....	DWG-124701
Insert; LL-2441 A/S 5000, Team Name	DWG-125290
Block Diagram- A/S 3000 or 5000 BB- VB and WR #2	DWG-125415

Refer to the information in **Section 2: Basic Operation (p. 4)** to start up the console and how to use the sport insert.

If an insert is lost/damaged, use a copy of the insert drawing until a replacement arrives.

Use the label sheet provided with the console (Daktronics part # LL-2458) to attach the correct code number label to the sport insert in the designated location. Write the code number in the space below. If viewing a digital copy of this manual, print this page and fill in the code number.

Write the correct code number here:

--	--	--	--

If the code number for a scoreboard is unknown, refer to **Appendix C**. If the scoreboard model number is unknown, refer to the documentation provided with the scoreboard.

Wrestling Keys



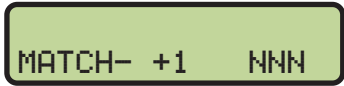
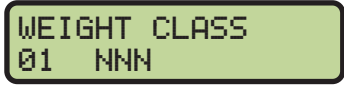

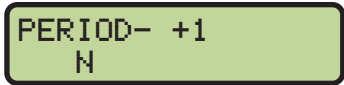

Match Number +1

Display	Action
 <p>MATCH- +1 NNN NNN = current setting</p>	<p>Press <MATCH +1> to increment the match number.</p> <p>The match number displays briefly.</p>
 <p>WEIGHT CLASS 01 NNN NNN = weight class</p>	<p>If weight classes are enabled, a prompt to select a weight class will be shown on the LCD. Use the arrow keys to select a weight class, and then press <ENTER>. The weight class displays in the Match digits.</p>

Period +1

Display	Action
 <p>PERIOD- +1 N N = current setting</p>	<p>Press <PERIOD +1> to increment the quarter number.</p> <p>The period number displays briefly.</p> <p>The period time will be set to the configured period time if the current time is at zero. There are 5 configured period times and the time will be set based on the current period number. If the current time was set before the <PERIOD +1> key is pressed, the time will not be adjusted.</p>

Set Main Clock (Period Times)

Display	Action
 <p>MM:SS = minutes, seconds</p>	<p>After the main clock has been stopped, press <SET MAIN CLOCK> to display the current time of the main clock.</p> <p>To change the time, enter the desired time using the number pad, and then press <ENTER>.</p> <p>Press <CLEAR> twice to cancel and return to the game.</p>
     <p>MM:SS = minutes, seconds</p>	<p>Press <SET MAIN CLOCK> a second, third, fourth, fifth, or sixth time to display the configured time for each clock period.</p> <p>To accept the displayed period length press <YES>.</p> <p>To decline the selection of the period length press <NO>.</p> <p>To change the period length and set the main clock, enter the new time in minutes and seconds using the number pad, and then press <ENTER>.</p> <p>Press <CLEAR> twice to cancel and return to the game.</p>

Home Advantage, Guest Advantage, Stop Advantage Clock

Display	Action
 <p>M:SS = minutes, seconds (main clock)</p> <p>M:SS.T = minutes, seconds, tenths of a second (advantage timer)</p> <p>G or H = guest or home</p>	<p>The main clock must be running to use the advantage timer.</p> <p>Press the <HOME (GREEN) ADVANTAGE> or <GUEST (RED) ADVANTAGE> key to start the advantage timer for the competitor that has control of the match. The competitor that has the net (most) advantage time is shown on the LCD display (<H or >G). The timer (AD TM on the display) counts up or down depending on which competitor is in control (last advantage key pressed) and which competitor has the net (most) advantage time. For example:</p> <p>If the home competitor is the first to control the match, press <HOME (GREEN) ADVANTAGE>. The display shows <H and the timer (AD TM) counts up.</p> <p>When the guest competitor gains control, press <GUEST (RED) ADVANTAGE>. The display still shows <H (because home still has the net advantage) but the timer (AD TM) counts down. The timer continues to count down until the <HOME (GREEN) ADVANTAGE> is pressed again or the timer reaches zero.</p> <p>If zero is reached, the display shows >G (which now has the net advantage) and the timer counts up.</p> <p>Press the <STOP ADVANTAGE CLOCK> key to stop the advantage timer when neither competitor is in control.</p>

Team Score (+1/-1)

Display	Action
 <p>NNN = current setting</p>	<p>Press <SCORE +1> or <SCORE -1> to increment or decrement the home or guest team score.</p> <p>Total score displays briefly.</p> <p>Pressing a <TEAM SCORE> key will cause the team scores to show up on the LCD (TM will show on the LCD to indicate this). Pressing a <MATCH SCORE> key will cause the match scores to show on the LCD (MAT will show on the LCD to indicate this).</p>

Match Score (+1/+2/+3/-1)



The home and guest **<MATCH SCORE +1>**, **<MATCH SCORE +2>**, and **<MATCH SCORE +3>** keys are used to increment the team score and the **<MATCH SCORE -1>** key is used to decrement the team score.

Display	Action
 <p>NN = current setting</p>	<p>Press the appropriate score key to increment or decrement the score for the home or guest team.</p> <p>The LCD shows which key was pressed and the new value for the team score of the corresponding team.</p> <p>Pressing a <MATCH SCORE> key will cause the match scores to show on the LCD (MAT will show on the LCD to indicate this). Pressing a <TEAM SCORE> key will cause the team scores to show up on the LCD (TM will show on the LCD to indicate this).</p>

Start/Stop Injury Time

Display	Action
 <p>M:SS = minutes, seconds (injury timer)</p> <p>M:SS.T = minutes, seconds, tenths of a second (advantage timer)</p> <p>G or H = guest or home</p>	<p>The maximum allowed injury time is set for each competitor at the beginning of a match and reset to this time when the Reset Match function is performed.</p> <p>When enabled, the injury times are displayed in the main clock digits, and the corresponding (home or guest) match score digits flash.</p> <p>The main clock must be stopped to use the injury timer.</p> <p>Press <START INJURY TIME> to start the injury timer for the home or guest competitor. The injury timer counts down from the maximum allowed time until <STOP INJURY TIME> is pressed or 0:00 is reached. The injury time is shown on the LCD display with H for home or G for guest.</p> <p>Press the <STOP INJURY TIME> key to stop the injury timer and return the period time to the main clock digits. A key press is required before the main clock digits return to period time. This gives the coach time to see how much injury time remains.</p>

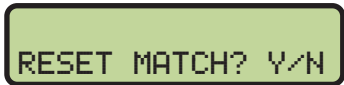
Reset Match

Display	Action
	<p>Press <YES> to clear all of the data for the last match or the match in progress and begin a new individual match.</p> <p>Press <NO> to resume the match in progress using the current data and exit the Menu.</p>
	<p>If weight classes are enabled, it will ask for the winner. Use the arrow keys to select HOME or GUEST, and then press <ENTER>.</p> <p>Enter the points for the win, and then press <ENTER>.</p>
 <p>HH:MM:SS = hours, minutes, seconds (Time of day) M:SS = minutes, seconds (elapsed time) N = home score X = guest score</p>	<p>The console will display the time of day, elapsed time of the match, and points scored in the match. This will display until a key is pressed.</p>

Start/Stop Blood Time

Display	Action
 <p>M:SS = minutes, seconds (blood timer)</p> <p>M:SS.T = minutes, seconds, tenths of a second (advantage timer)</p> <p>G or H = guest or home</p>	<p>The maximum allowed blood time is set for each competitor at the beginning of a match and reset to this time when the Reset Match function is performed.</p> <p>When enabled, the blood times are displayed in the main clock digits and the corresponding (home or guest) match score digits flash.</p> <p>The main clock must be stopped to use the blood timer.</p> <p>Press <START BLOOD TIME> to start the blood timer for the home or guest competitor. The injury/blood timer counts down from the maximum allowed time until <STOP BLOOD TIME> is pressed or 0:00 is reached. The blood time is shown on the LCD display with H for home or G for guest.</p> <p>Press the <STOP BLOOD TIME> key to stop the blood timer and return the period time to the main clock digits.</p> <p>A key press is required before the main clock digits return to period time. This gives the coach time to see how much blood time remains.</p>

Start/Stop Recovery Time

Display	Action
 <p>M:SS = minutes, seconds (recovery timer)</p> <p>M:SS.T = minutes, seconds, tenths of a second (advantage timer)</p> <p>G or H = guest or home</p>	<p>The recovery time is set to the configured recovery time for each competitor when the <START HOME RECOVERY> or <START GUEST RECOVERY> keys are pressed.</p> <p>When enabled, the recovery times are displayed in the main clock digits and the corresponding (home or guest) match score digits flash.</p> <p>The main clock must be stopped to use the recovery timer.</p> <p>After pressing a start recovery key for the home or guest competitor, the recovery timer counts down from the maximum allowed time until <STOP RECOVERY TIME> is pressed or 0:00 is reached.</p> <p>Press <STOP RECOVERY TIME> to stop the recovery timer and return the period time to the main clock digits.</p>

Edit

Press **<EDIT>** followed by one of the keys below to quickly edit the value.

Home Advantage

Display	Action
 <p>MM:SS.T = minutes, seconds, tenths of a second</p>	<p>Press <EDIT> followed by <HOME (GREEN) ADVANTAGE> to display the current advantage time for the home competitor.</p> <p>Enter the advantage time for the home competitor using the number pad, and then press <ENTER>.</p> <p>Press <CLEAR> twice to cancel and return to the game.</p>

Guest Advantage

Display	Action
 <p>MM:SS.T = minutes, seconds, tenths of a second</p>	<p>Press <EDIT> followed by <GUEST (RED) ADVANTAGE> to display the current advantage time for the guest competitor.</p> <p>Enter the advantage time for the guest competitor using the number pad, and then press <ENTER>.</p> <p>Press <CLEAR> twice to cancel and return to the game.</p>

Blood Time

Display	Action
<p>MM:SS.T = minutes, seconds, tenths of a second</p>	<p>Press <EDIT> followed by either BLOOD TIME key for the home or guest team to display the current blood time setting.</p> <p>Enter the maximum allowed blood time in minutes and seconds using the number pad, and then press the <ENTER> key.</p>

Injury Time

Display	Action
<p>MM:SS.T = minutes, seconds, tenths of a second</p>	<p>Press <EDIT> followed by either INJURY TIME key for the home or guest team to display the current injury time setting.</p> <p>Enter the maximum allowed injury time in minutes and seconds using the number pad, and then press the <ENTER> key.</p>

Match Number, Period, Team Score, Match Score

The home and guest **<MATCH NUMBER>**, **<PERIOD>**, **<TEAM SCORE>**, and **<MATCH SCORE>** keys are all edited in the same way. **<TEAM SCORE +1>** is used as an example below.

Display	Action
<p>NNN = current setting</p>	<p>Press <EDIT> followed by the appropriate statistic key to display the current setting.</p> <p>Enter the correct value using the number pad, and then press <ENTER>.</p>

Menu

Press **<MENU>** to access general and sport-specific options. Use the up and down arrow keys to scroll through the menu list. Press **<MENU>** again at any time to return to the game in progress.

New Game

Display	Action
	<p>Press <ENTER> to clear all data for the current game in progress and begin a new game.</p>

New Code

Display	Action
	<p>Press <ENTER> to switch to a different sport code through the SELECT CODE prompt. Refer to Start Up (p. 6) for more information on sport codes.</p>

Dimming Menu

Refer to **Dimming Menu (p. 15)**.

Home Roster, Guest Roster



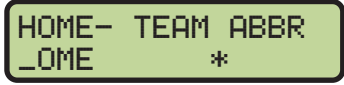

Use the **Home Roster** and **Guest Roster** menus to set up team names. **Home Roster** is used as an example below.

Display	Action
<pre>MENU- ROSTER SELECT HOME</pre>	Press <ENTER> to select the Roster submenu.
<pre>HOME- TEAM NAME EDIT SETTINGS?</pre> <pre>HOME- TEAM NAME SELECT WIDTH</pre> <pre>HOME- TEAM NAME SIZE NN</pre> <p>NN = current setting</p>	<p>Press <ENTER> to select the Team Name Edit Settings submenu.</p> <p>Press <ENTER> to select the width (in pixels) of the Team Name Message Centers (TNMC) used on the scoreboard.</p> <p>Select from 16, 32, 48, or 64, and then press <ENTER>.</p>
<pre>HOME- TEAM NAME SELECT FONT</pre> <pre>HOME- TEAM NAME 8H SINGLE</pre>	<p>On the following menu, press <ENTER> and use the left/right arrows to select one of the following fonts for the team name: 8H SINGLE (single stroke), 8H BOLD (double stroke), 8H NARROW (single stroke, alternate narrow), or 8H NARROW BOLD (double stroke, alternate narrow)</p> <p>After selecting a font type, press <ENTER>.</p>
<pre>HOME- TEAM NAME _OME *</pre>	<p>Use the TEAM NAME (LL-2441) insert to change the Team Name Message Center (TNMC) settings.</p> <p>Type in a team name of up to 15 characters and press <ENTER>.</p> <p>Refer to Team Name Entry (p. 19) for more information.</p>
<pre>HOME- TEAM ABBR EDIT SETTINGS?</pre> <pre>HOME- TEAM ABBR SELECT WIDTH</pre> <pre>HOME- TEAM ABBR SIZE NN</pre> <p>NN = current setting</p>	<p>Press <ENTER> to select the Team Abbreviation Edit Settings submenu.</p> <p>Press <ENTER> to select the width (in pixels) of the Team Name Message Centers (TNMC) used on the scoreboard.</p> <p>Select from 16, 32, 48, or 64, and then press <ENTER>.</p>
<pre>HOME- TEAM ABBR SELECT FONT</pre> <pre>HOME- TEAM ABBR 8H SINGLE</pre>	<p>On the following menu, press <ENTER> and use the left/right arrows to select one of the following fonts for the team name: 8H SINGLE (single stroke), 8H BOLD (double stroke), 8H NARROW (single stroke, alternate narrow), or 8H NARROW BOLD (double stroke, alternate narrow)</p> <p>After selecting a font type, press <ENTER>.</p>

Display	Action
	<p>Type in a team abbreviation of up to 10 characters and press <ENTER>.</p> <p>Reinsert the WRESTLING (LL-2435) insert to continue.</p>

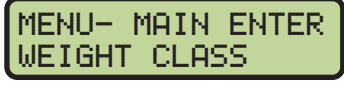
Weight Class

Use the **WEIGHT CLASS** menu to enter the weight class values.

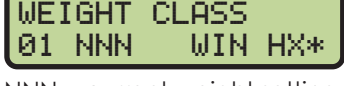
Display	Action
	<p>Press <ENTER> to select the Weight Class submenu.</p>
	<p>A total of 14 weight classes may be entered. Use the up/down arrow keys to select the index of the weight class to edit, and press <ENTER>.</p> <p>Enter a new value for the weight class, and then press <ENTER>.</p> <p>Set the winner of this weight class. This is used mainly for editing a winner that was set to the wrong side. Use the arrow keys to select H or G as the winner, and then press <ENTER>.</p> <p>Enter the score for the winner, and then press <ENTER>.</p> <p>NNN = current weight setting G or H = guest or home X = current games won</p>
	
	
	

Display Menu

Refer to **Display Menu (p. 15)** for more information.

Color Menu

Refer to **Color Menu (p. 16)** for more information.

Time of Day

Refer to **Time of Day (p. 17)** for more information.

Edit Settings

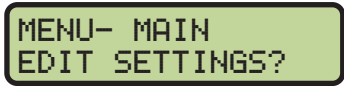
Display	Action
	<p>From the Main Menu, select the EDIT SETTINGS submenu to modify the settings below.</p>

Main Clock

The settings for the Main Clock are used with the **<SET MAIN CLOCK>** key.

The period length is used differently depending on the direction of the main clock. For count down, the main clock is set to the selected length, decrements towards zero, and stops at zero. For count up, the main clock is set to zero, increments towards the selected length, and stops when the selected length is reached.

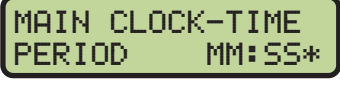
Display	Action
	<p>When the main clock is set to count down and tenths of a second is selected, the main clock displays in tenths of a second remaining when the time is below one minute.</p> <p>Press <YES> to set the main clock to display tenths of a second. Press <NO> to display whole seconds.</p>
 <p>MM:SS = minutes, seconds</p>	<p>Enter the correct amount of time per period in minutes and seconds using the number pad, and then press <ENTER>.</p> <p>Note: Pressing <ENTER> to select the period time as the main clock setting will increment the current period number if the clock value was previously zero.</p>

Blood/Injury Time

The maximum allowed blood and injury times are set for each competitor at the beginning of a match and reset to these times when the Reset Match function is performed.

When enabled, the blood and injury times are displayed in the main clock digits and the corresponding (home or guest) match score digits flash.

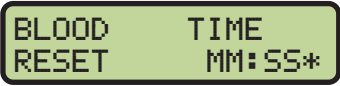
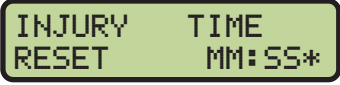
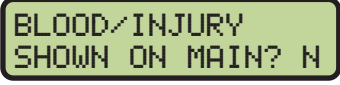
Display	Action
 <p>MM:SS = minutes, seconds</p>	<p>Enter the cumulative time for blood time outs in minutes and seconds using the number pad, and then press <ENTER>.</p>
 <p>MM:SS = minutes, seconds</p>	<p>Enter the cumulative time for injury time outs in minutes and seconds using the number pad, and then press <ENTER>.</p>
	<p>Press <YES> to display the blood, injury, and recovery times on the LCD and the main clock digits of the scoreboard while the blood, injury, or recovery clock is active.</p> <p>Press <NO> to display the times on the LCD only.</p>

Recovery Time

The maximum allowed recovery times are set for each competitor at the beginning of a match and reset to these times whenever a recovery clock is activated.

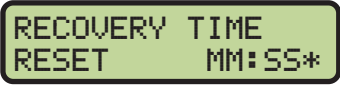
Display	Action
 <p>MM:SS = minutes, seconds</p>	<p>Enter the time for recovery time outs in minutes and seconds using the number pad, and then press <ENTER>.</p>

Select Captions

Display	Action
	<p>This menu option allows for the controlled backlit captions to be turned ON/OFF.</p> <p>Press the <1> key to select ON and OFF for captions controlled by control #1.</p> <p>Press the <2> key to select ON and OFF for captions controlled by control #2.</p>

Weight Class

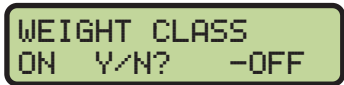
Display	Action
	<p>This setting allows the use of weight classes. Press <YES> to use weight classes, or press <NO> to select not to use weight classes.</p>

Display Lines for Weight Class

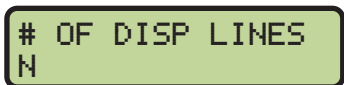
Display	Action
 <p>N = current setting</p>	<p>This setting represents the number of lines used on the stat panel displays. It can only be set to 5 or 6.</p> <p>Press the <5> or <6> key, and then <ENTER>.</p>

Display Team Score

Display	Action
	<p>This menu option allows for selection of having the Team Score display on the Matside advantage/team score module. If set to display, it will show team score after the match is reset until an advantage time is started.</p> <p>Press <YES> to select display ON. Press <NO> to select display OFF.</p>

Shot Horn Control

Display	Action
	<p>This menu option allows the selection of what will control the output for the shot clock horn. Use the left or right arrow keys to scroll to the desired setting, or use the <0> – <3> number keys.</p> <p>Press <ENTER> when the desired setting is shown.</p> <p>0 = NO CONTROL, 1 = MAIN HORN, 2 = SHOT HORN, 3 = MAIN & SHOT</p>

Light Control

Display	Action
	<p>This menu option allows the selection of what will control the output for the light strip displays. Use the left or right arrow keys to scroll to the desired setting, or use the <1> – <6> number keys.</p> <p>Press <ENTER> when the desired setting is shown.</p> <p>1 = CLK=0, 2 = CLK STOP, 3 = (not used), 4 = MAIN HORN, 5 = CLK=0 & HRN, 6 = STOP & HRN</p>

Switch Output

Refer to **Switch Output (p. 18)** for more information.

Default Settings

Print this page if necessary, and record any custom settings for this installation:

Setting	Default	Custom 1	Custom 2	Custom 3	Custom 4
Tenth of a Second	No				
Period Length	3:00				
Period 2 Length	3:00				
Period 3 Length	3:00				
Period 4 Length	3:00				
Period 5 Length	3:00				
Period 6 Length	3:00				
Blood Time	5:00				
Injury Time	2:00				
Blood Show on Main	No				
Recovery Time	2:00				
Select Captions	1-ON				
Weight Class On	No				
# of Display Lines	6				
Display Team Score	No				
Shot Horn Control	Main Horn				
Light Control	Clk=0				
Switch Output	1-Clock = 0				

This page intentionally left blank.

A Reference Drawings

Refer to **Resources (p. 2)** for information regarding how to read the drawing number. Any contract-specific drawings take precedence over the general drawings.

Reference Drawings:

Rear View, A/S 5010 Connector Assignments.....	DWG-102142
Block Diagram: AS5000 BB- VB and WR #1.....	DWG-124686
Block Diagram: AS5000 BB- VB and WR #3.....	DWG-124688
Schematic; Dual 1/4" Phone J-Box w/Shunt Jack.....	DWG-125316
Block Diagram- A/S 3000 or 5000 BB- VB and WR #2	DWG-125415
All Sport 5000, 25pin PCB J-Box Wiring.....	DWG-125416
Block Diagram: A/S 3000 or 5000 BB- VB and WR #4.....	DWG-125417
All Sport 5000 Current Loop Output Specifications	DWG-128429
Channel Selection; Multiple Broadcast Group, Gen IV	DWG-203113
Installation Details, Gen VI Channel Selection Guide.....	DWG-1109870

This page intentionally left blank.

ALL SPORT 5010

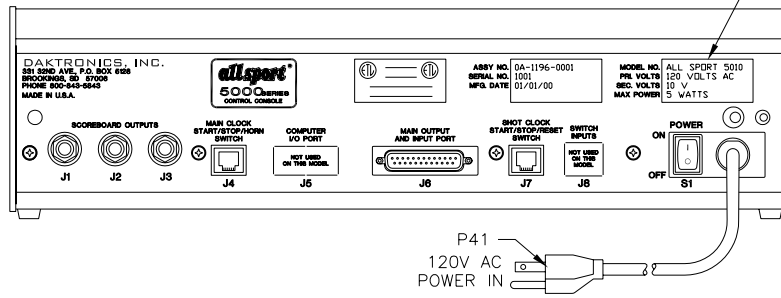

LOOK HERE TO DETERMINE THE MODEL NUMBER AND POWER SPECIFICATIONS

ALL SPORT 5012

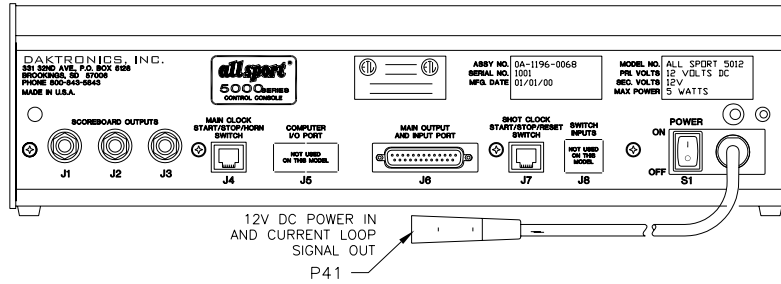

ALL SPORT 5020

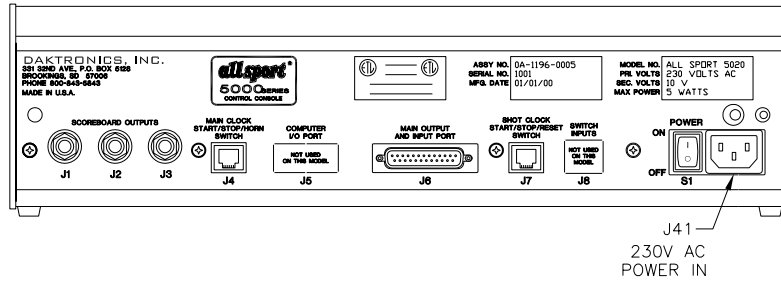

J1-J3 - OUTPUT #1-#3	
CONTACT	FUNCTION
TIP	CURRENT LOOP OUTPUT 1 +
RING	CURRENT LOOP OUTPUT 1 -
SHAFT	GND

J4 - START/STOP/HORN	
PIN #	FUNCTION
1	SWITCH INPUT 2 -
2	SWITCH INPUT 1 -
3	RELAY OUTPUT -
4	RELAY OUTPUT +
5	SWITCH INPUT 1 +
6	SWITCH INPUT 2 +

J6 - MAIN PORT	
PIN #	FUNCTION
1	EARTH
2	RS232 RECEIVE +
3	RS232 TRANSMIT +
4	NOT USED
5	NOT USED
6	NOT USED
7	C. L. OUTPUT 4 -/RS232 GND
8	SWITCH INPUT 1 +
9	CURRENT LOOP INPUT +
10	CURRENT LOOP INPUT -
11	RELAY OUTPUT +
12	NOT USED
13	NOT USED
14	CURRENT LOOP OUTPUT 1 +
15	CURRENT LOOP OUTPUT 1 -
16	CURRENT LOOP OUTPUT 2 +
17	CURRENT LOOP OUTPUT 2 -
18	CURRENT LOOP OUTPUT 3 +
19	CURRENT LOOP OUTPUT 3 -
20	NOT USED
21	SWITCH INPUT 1 -
22	CURRENT LOOP OUTPUT 4 +
23	RELAY OUTPUT -
24	10V AC/DC INPUT-P
25	10V AC/DC INPUT-N

J7 - SHOT/PLAY CLOCK	
PIN #	FUNCTION
1	SWITCH INPUT 5 -
2	SWITCH INPUT 4 -
3	SWITCH INPUT 3 -
4	SWITCH INPUT 3 +
5	SWITCH INPUT 4 +
6	SWITCH INPUT 5 +

FOR STANDARD CODES, THESE FUNCTIONS ARE USUALLY ASSIGNED TO THE FOLLOWING TASKS:

FUNCTION	USUAL TASK
SW IN 1	MAIN CLOCK STOP/START
SW IN 2	MAIN CLOCK HORN
SW IN 3	NOT USED
SW IN 4	SHOT/PLAY CLOCK STOP
SW IN 5	SHOT/PLAY CLOCK RESET
SW OUT	CLOCK STOP OUT
CL OUT 1	SCOREBOARD OUTPUT
CL OUT 2	SCOREBOARD OUTPUT
CL OUT 3	SCOREBOARD OUTPUT
CL OUT 4	DATA STREAM

ALL SPORT 5000 SERIES MODELS	
MODEL #	FUNCTION
5010	120V, STANDARD PROGRAMMING
5020	230V, STANDARD PROGRAMMING

REV.	DATE	DESCRIPTION	BY	APPR.
3	05 OCT 01	ADDED A/S 5012 TO LAYOUT CHANGED DWG SCALE FROM 1=3 TO 1=4	NW	
2	24 APR 99	CHANGED TO BE FOR A/S 5010 CONSOLES ONLY	EB	
1	13 APR 99	ADDED J10 ADDED A/S 5010 LAYOUT	EB	

DAKTRONICS, INC. BROOKINGS, SD 57006	
PROJ: ALL SPORT 5000 SERIES CONSOLES	
TITLE: REAR VIEW, A/S 5010 CONNECTOR ASSIGNMENTS	
DES. BY: EBRAVEK	DRAWN BY: EBRAVEK
DATE: 27APR98	
REVISION	APPR. BY:
	SCALE: 1=4
1196-R04A-102142	

TYPICAL INSTALLATION SHOWN

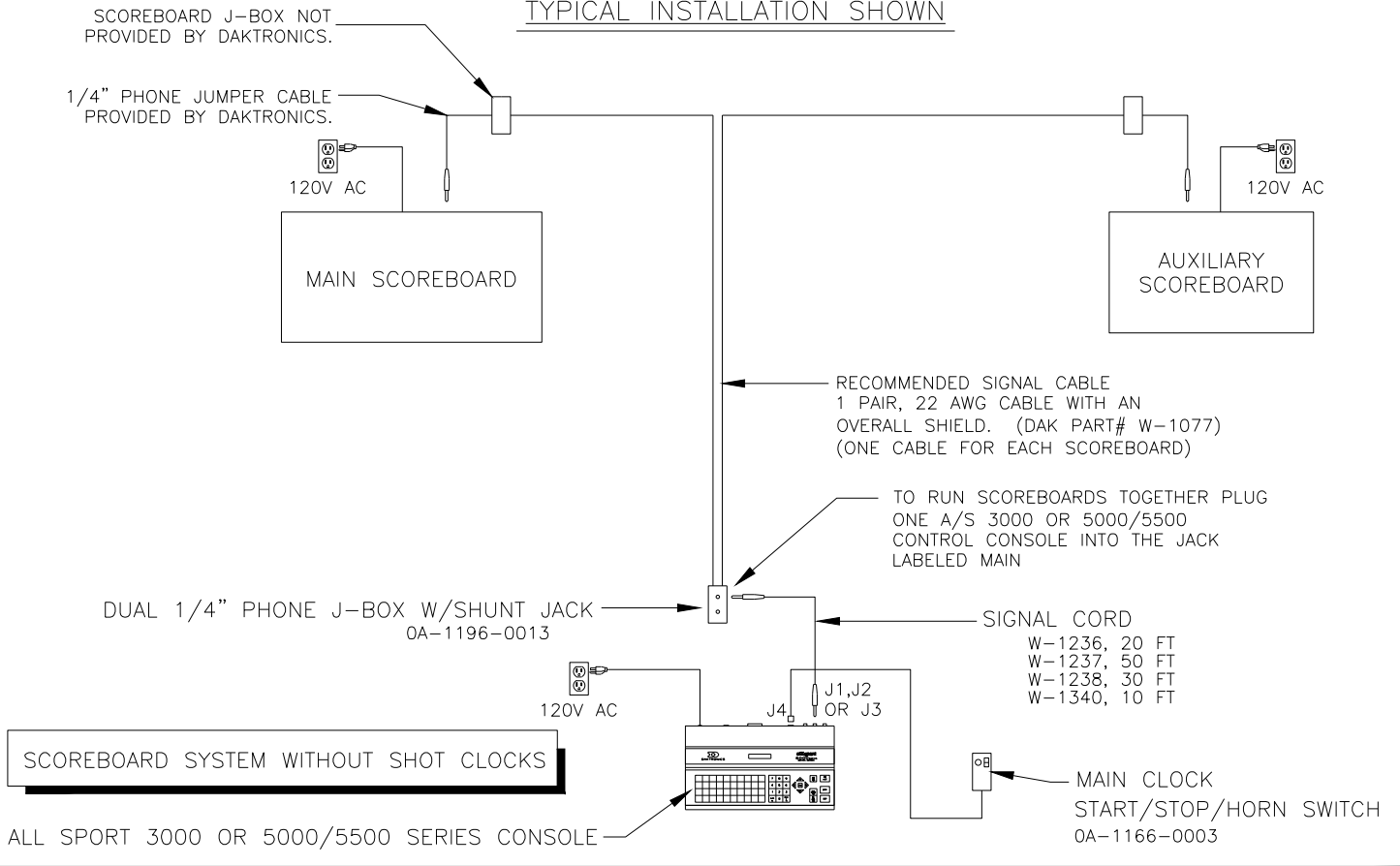

SEPARATE SCOREBOARD CONTROL

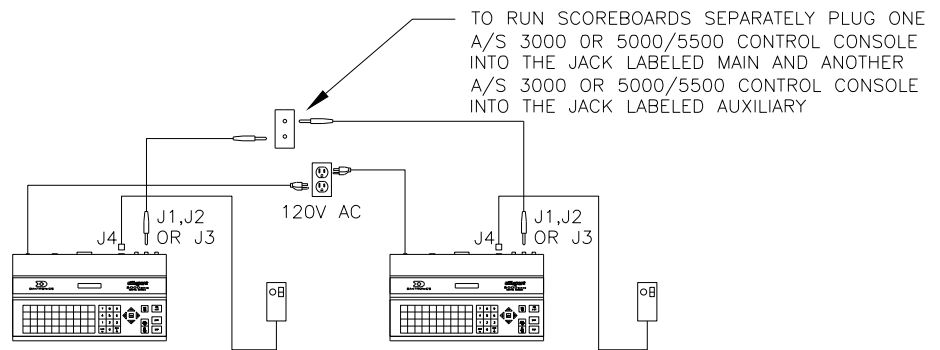

0A-1196-0013 J-BOX

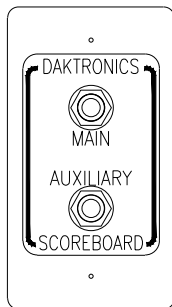

TYPICAL 0A-1196-0013 J-BOX WIRING

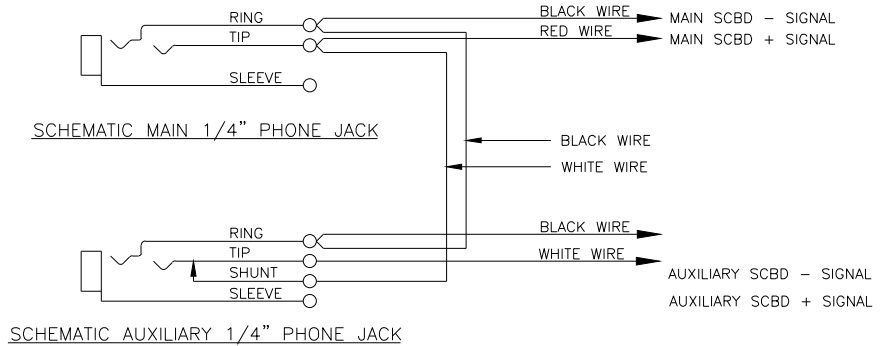

DAKTRONICS, INC.

BROOKINGS, SD 57006

DO NOT SCALE DRAWING

THE CONCEPTS EXPRESSED AND DETAILS SHOWN ON THIS DRAWING ARE CONFIDENTIAL AND PROPRIETARY. DO NOT REPRODUCE BY ANY MEANS WITHOUT THE EXPRESSED WRITTEN CONSENT OF DAKTRONICS, INC. COPYRIGHT 2011 DAKTRONICS, INC.

PROJ: ALL SPORT 5000/5500

TITLE: BLOCK DIAGRAM: AS5000 BB- VB AND WR #1

DESIGN: DRAWN: E BRAVEK DATE: 29 NOV 99

SCALE: NONE

SHEET REV JOB NO: FUNC-TYPE-SIZE

02

P1196

R-04-A

124686

REV 02 DATE: 17 AUG 11 UPDATED THE BOARDER AND TITLE BLOCK UPDATED TEXT TO INCLUDE 5500 SERIES

BY: JJL

REV 01 DATE: 26 APR 00 ADDED A/S 3000

BY: DKD

1/4" PHONE JUMPER CABLE PROVIDED BY DAKTRONICS.

TYPICAL INSTALLATION SHOWN

SCOREBOARD J-BOXES NOT PROVIDED BY DAKTRONICS.

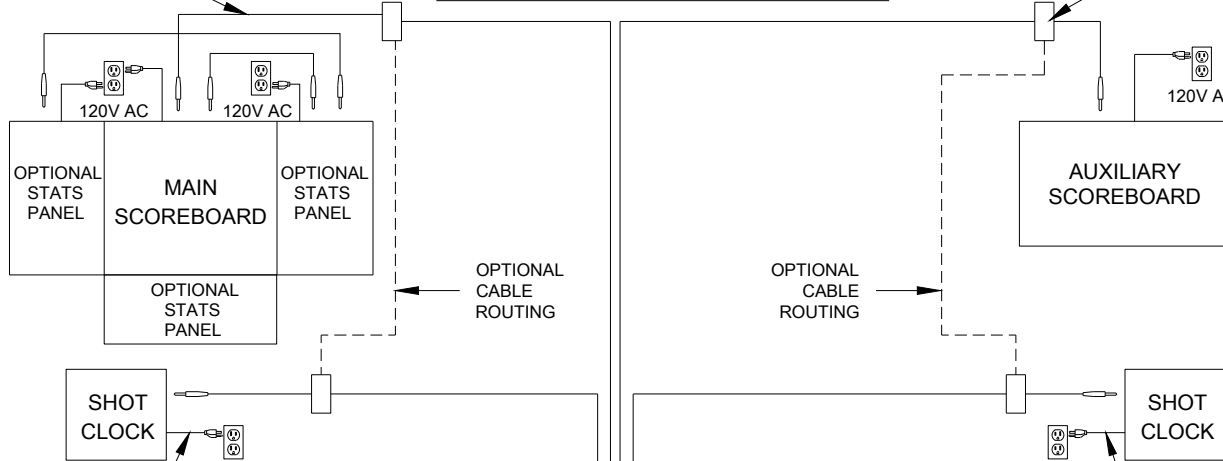

* POWER CORD INCLUDED ON MODELS BB-2114, BB-2115 AND BB-3114 ONLY

*POWER CORD PROVIDED BY OTHER

- *SIGNAL INSTRUCTIONS FOR SCOREBOARD WITH STATS PANELS:**
- SIGNAL FROM SOURCE LANDS TO MAIN BASKETBALL SCOREBOARD.
 - THEN OUT FROM SCOREBOARD TO IN ON STATS PANEL.
 - AND OUT FROM STATS PANEL TO IN ON OTHER STATS PANEL.

RECOMMENDED SIGNAL CABLE
1 PAIR, 22 AWG CABLE WITH AN OVERALL SHIELD. (DAK PART# W-1077)
(ONE CABLE FOR EACH SCOREBOARD)

TO RUN SCOREBOARDS TOGETHER PLUG ONE A/S 5000/5500 CONTROL CONSOLE INTO THE JACK LABELED MAIN

DUAL 1/4" PHONE J-BOX W/SHUNT JACK
0A-1196-0013

SCOREBOARD SYSTEM WITH SHOT CLOCKS

SIGNAL CORD
W-1236, 20 FT
W-1237, 50 FT
W-1238, 30 FT
W-1340, 10 FT

SHOT CLOCK CONTROL
0A-1196-0031

MAIN CLOCK
START/STOP/HORN SWITCH
0A-1166-0003

ALL SPORT 5000/5500 SERIES CONSOLE

POWER CORD PROVIDED BY OTHER

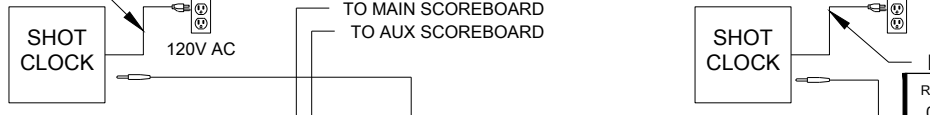

DUAL 1/4" PHONE J-BOX W/SHUNT JACK
0A-1196-0013

PORTABLE SHOT CLOCK CABLING

ALL SPORT 5000/5500 SERIES CONSOLE

SHOT CLOCK SIGNAL CABLES
W-1381, 100 FT

SIGNAL CORD
W-1236, 20 FT
W-1237, 50 FT
W-1238, 30 FT
W-1340, 10 FT

SHOT CLOCK CONTROL
0A-1196-0031

MAIN CLOCK
START/STOP/HORN SWITCH
0A-1166-0003

POWER CORD PROVIDED BY OTHERS

REV 09	DATE: 09 MAY 22	AMENDED NOTE TO SAY BB-2114/BB-3114/BB-2115 INCLUDE POWER CORDS	BY: TBS
REV 08	DATE: 15 APR 19	ADDED NOTE THAT BB-2114/BB-3114 INCLUDE POWER CORDS	BY: KDM
REV 07	DATE: 28 NOV 18	ADDED NOTE THAT SHOT CLOCK POWER CORDS ARE PROVIDED BY OTHER	BY: KDM

DAKTRONICS THE CONCEPTS EXPRESSED AND DETAILS SHOWN ON THIS DRAWING ARE CONFIDENTIAL AND PROPRIETARY. DO NOT REPRODUCE BY ANY MEANS WITHOUT THE EXPRESS WRITTEN CONSENT OF DAKTRONICS, INC. OR ITS WHOLLY OWNED SUBSIDIARIES. COPYRIGHT 2018 DAKTRONICS, INC. (USA)

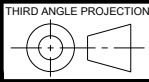

PROJECT: ALLSPORT 5000/5500		SHEET		REV
TITLE: BLOCK DIAGRAM: AS5000 BB- VB AND WR #3		DATE: 29 NOV 99		09
SCALE: NONE		DIM UNITS: INCHES [MILLIMETERS]		
DESIGN: E BRAVEK		DO NOT SCALE DRAWING		
DRAWN: E BRAVEK		JOB NO. P1196	FUNC - TYPE - SIZE R - 04 - A	124688

NO.	DATE	DESCRIPTION
1	09/05/22	AMENDED NOTE TO SAY BB-2114/BB-3114/BB-2115 INCLUDE POWER CORDS
2	04/15/19	ADDED NOTE THAT BB-2114/BB-3114 INCLUDE POWER CORDS
3	11/28/18	ADDED NOTE THAT SHOT CLOCK POWER CORDS ARE PROVIDED BY OTHER

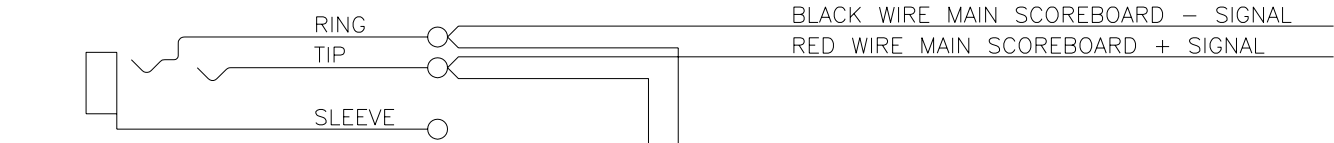

SCHEMATIC MAIN 1/4" PHONE JACK

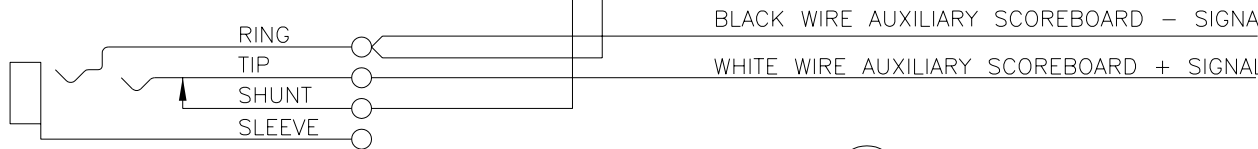

SCHEMATIC AUXILIARY 1/4" PHONE JACK

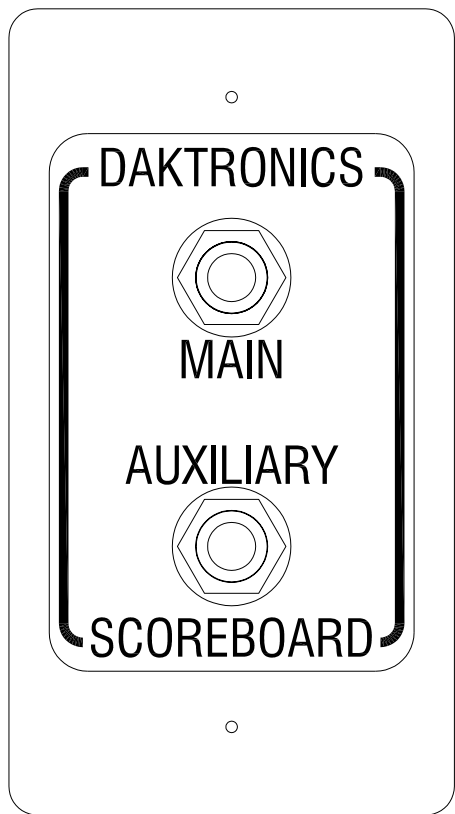

0A-1196-0013

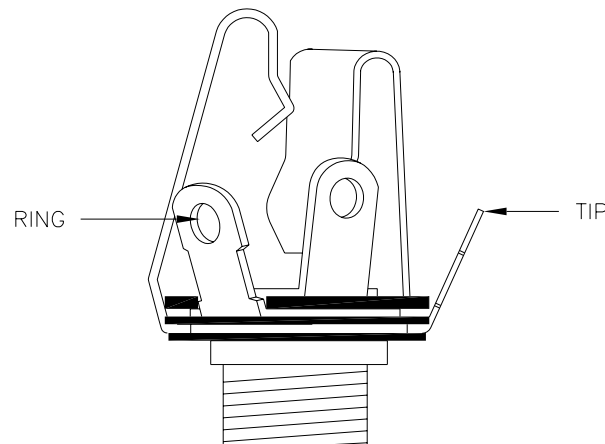

MAIN
PHONE JACK
J-1003

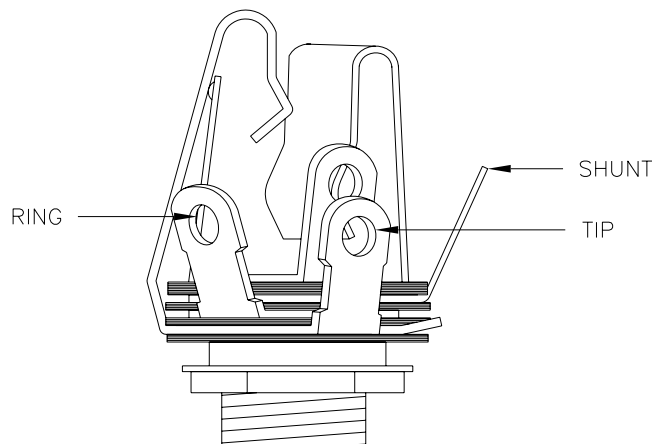

AUXILIARY
PHONE JACK
J-1131

DAKTRONICS, INC. BROOKINGS, SD 57006			
PROJ:			
TITLE: SCHEMATIC; DUAL 1/4" PHONE J-BOX W/SHUNT JACK			
DES. BY: E BRAVEK		DRAWN BY: E BRAVEK	
		DATE: 15 DEC 99	
REVISION	APPR. BY:	1196-R03A-125316	
00	SCALE: NONE		

REV.	DATE	DESCRIPTION	BY	APPR.

TYPICAL INSTALLATION SHOWN

SCOREBOARD J-BOXES NOT PROVIDED BY DAKTRONICS.

1/4" PHONE JUMPER CABLE PROVIDED BY DAKTRONICS.

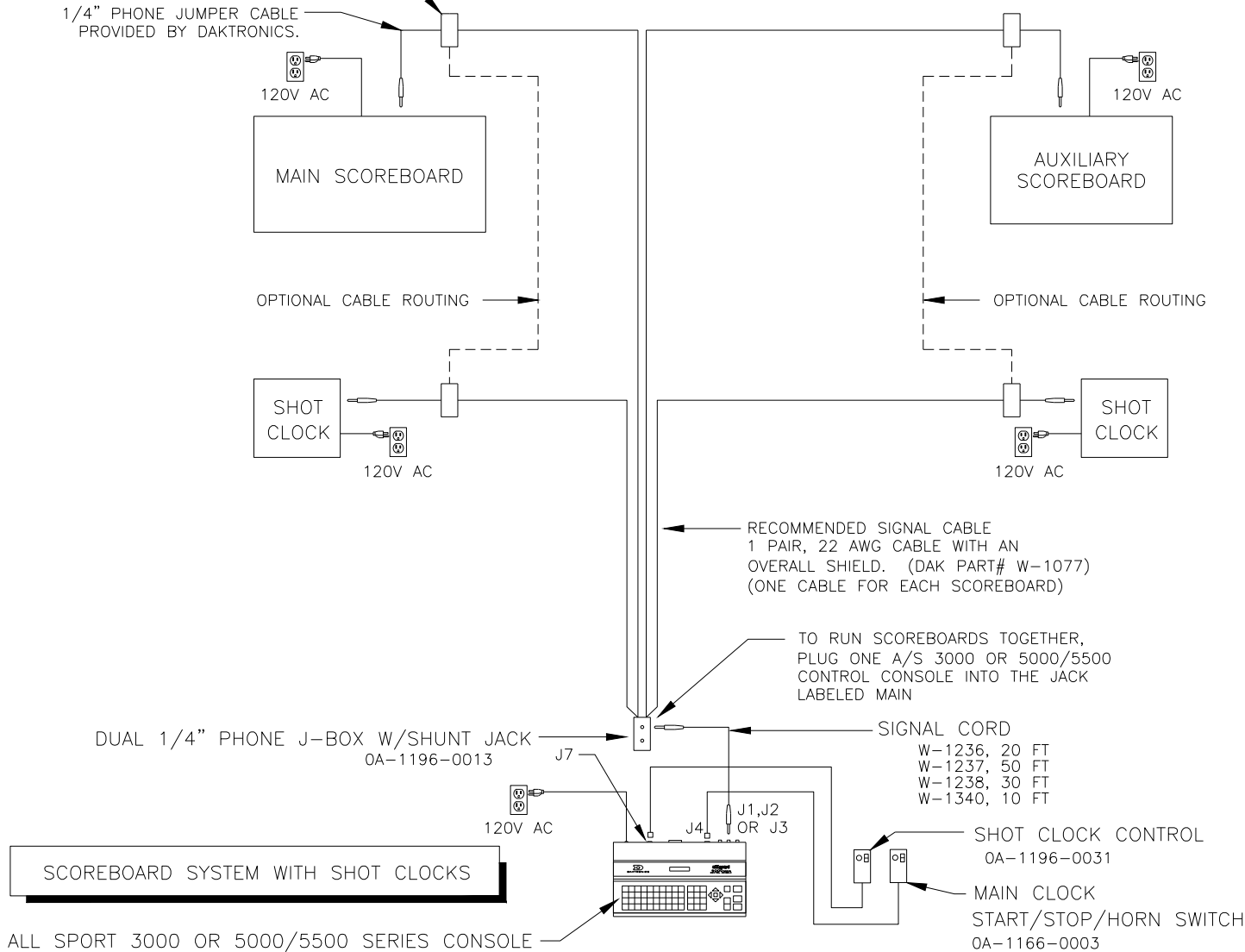

0A-1196-0013 J-BOX

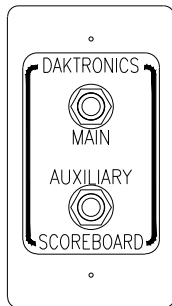

TYPICAL 0A-1196-0013 J-BOX WIRING

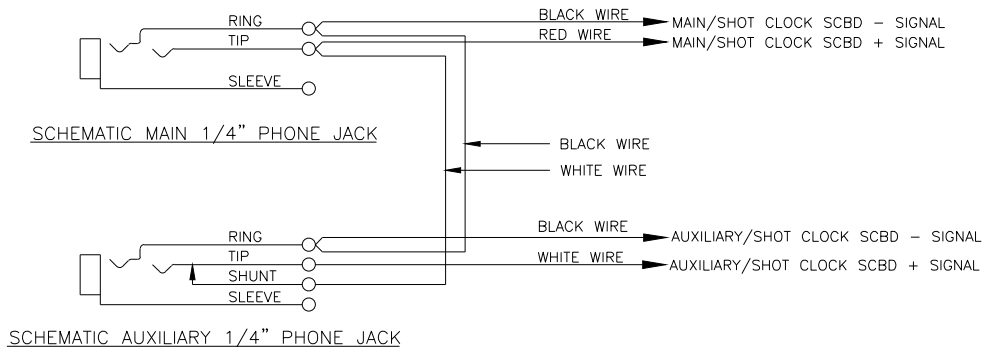

DAKTRONICS, INC.
BROOKINGS, SD 57006

THE CONCEPTS EXPRESSED AND DETAILS SHOWN ON THIS DRAWING ARE CONFIDENTIAL AND PROPRIETARY. DO NOT REPRODUCE BY ANY MEANS WITHOUT THE EXPRESSED WRITTEN CONSENT OF DAKTRONICS, INC. COPYRIGHT 2011 DAKTRONICS, INC.

REV 04	DATE: 24 AUG 11	UPDATED TEXT TO INCLUDE 5500 SERIES UPDATED TITLE BLOCK	BY: J JL
3	17 JAN 02	CHANGED 0A-1166-4 TO 0A-1196-31	J JS
02	26 APR 00	ADDED A/S 3000	DKD
1	29 DEC 99	ADDED SHOT CLOCK REMOTE START STOP TO A/S 5000 CONTROLLER	EB

DO NOT SCALE DRAWING			
PROJ: ALL SPORT 5000/5500			
TITLE: BLOCK DIAGRAM- A/S 3000 OR 5000 BB- VB AND WR #2			
DESIGN:	DRAWN: E BRAVEK	DATE: 15 DEC 99	
SCALE: NONE			
SHEET	REV	JOB NO:	FUNC-TYPE-SIZE
	04	P1196	R-04-A
			125415

REV.	DATE	DESCRIPTION	BY	APPR.

STRIP 1/4" OF INSULATION OFF OF EACH WIRE.

INSERT WIRE IN THE CORRECT POSTION.

USING A SMALL FLAT HEAD SCREW DRIVER TIGHTEN THE TERMINAL BLOCK TILL WIRE IS HELD IN PLACE. MAKE SURE TO NOT HAVE ANY EXCESS UNINSULATED WIRE STICKING OUT OF TERMINAL. BLOCK POSITION

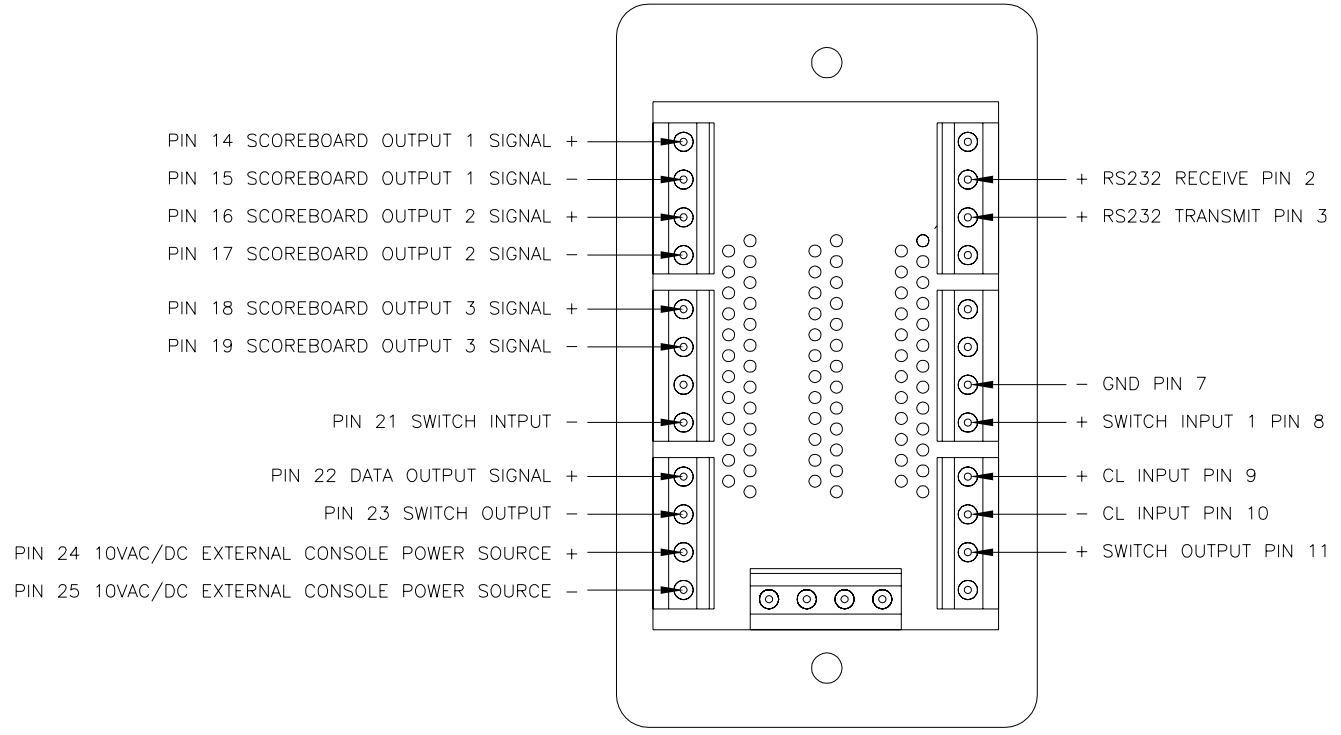

REAR VIEW OF J-BOX FACEPLATE

PROJ:	DAKTRONICS, INC. BROOKINGS, SD 57006
TITLE:	ALL SPORT 5000, 25PIN PCB J-BOX WIRING
DES. BY:	EBRAVEK
DRAWN BY:	EBRAVEK
DATE:	15 DEC 99
REVISION	APPR. BY: 1196-R01A-125416
SCALE:	1=3

01	26 APR 00	ADDED A/S 3000	DKD
02	31 JAN 07	UPDATED DRAWING TO SHOW SECOND ALL SPORT	MWM
03	18 DEC 08	UPDATED DRAWING WITH PROPER SHIELDING	DKD
04	24 AUG 11	UPDATED DRAWING TO INCLUDE 5500 SERIES UPDATED TITLE BLOCK	JUL

TYPICAL INSTALLATION SHOWN

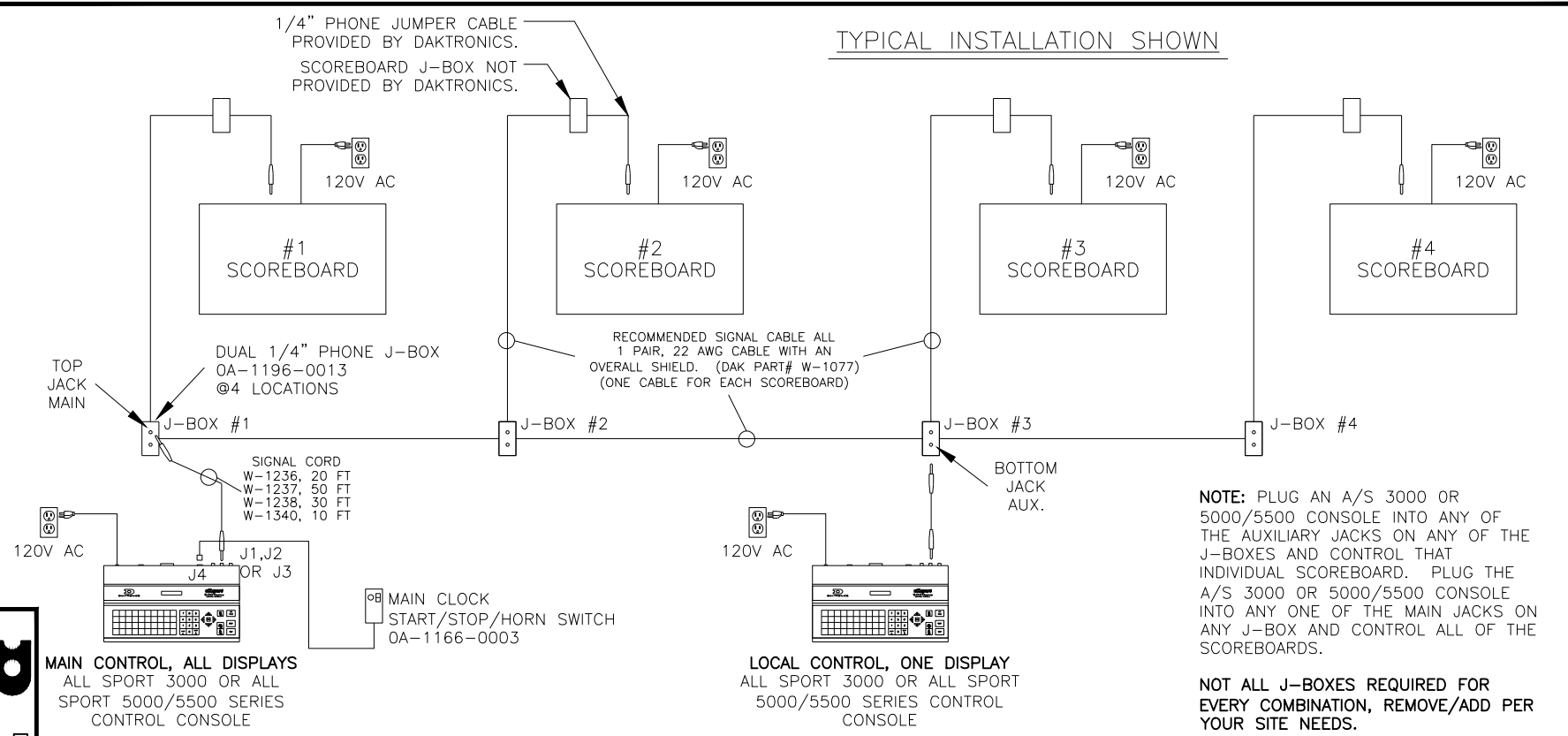

DAKTRONICS, INC.
BROOKINGS, SD 57006

THE CONCEPTS EXPRESSED AND DETAILS SHOWN ON THIS DRAWING ARE CONFIDENTIAL AND PROPRIETARY. DO NOT REPRODUCE BY ANY MEANS WITHOUT THE EXPRESSED WRITTEN CONSENT OF DAKTRONICS, INC. COPYRIGHT 2011 DAKTRONICS, INC.

Proj: ALL SPORT 5000/5500
DO NOT SCALE DRAWING

Rev: 04
Job No: P1196
Func-Type-Size: R-01-A

Scale: NONE

Design: ERBAVEK
Drawn: ERBAVEK
Date: 24 JAN 00

Title: BLOCK DIAGRAM: A/S 3000 OR 5000 BB-VB AND WR #4

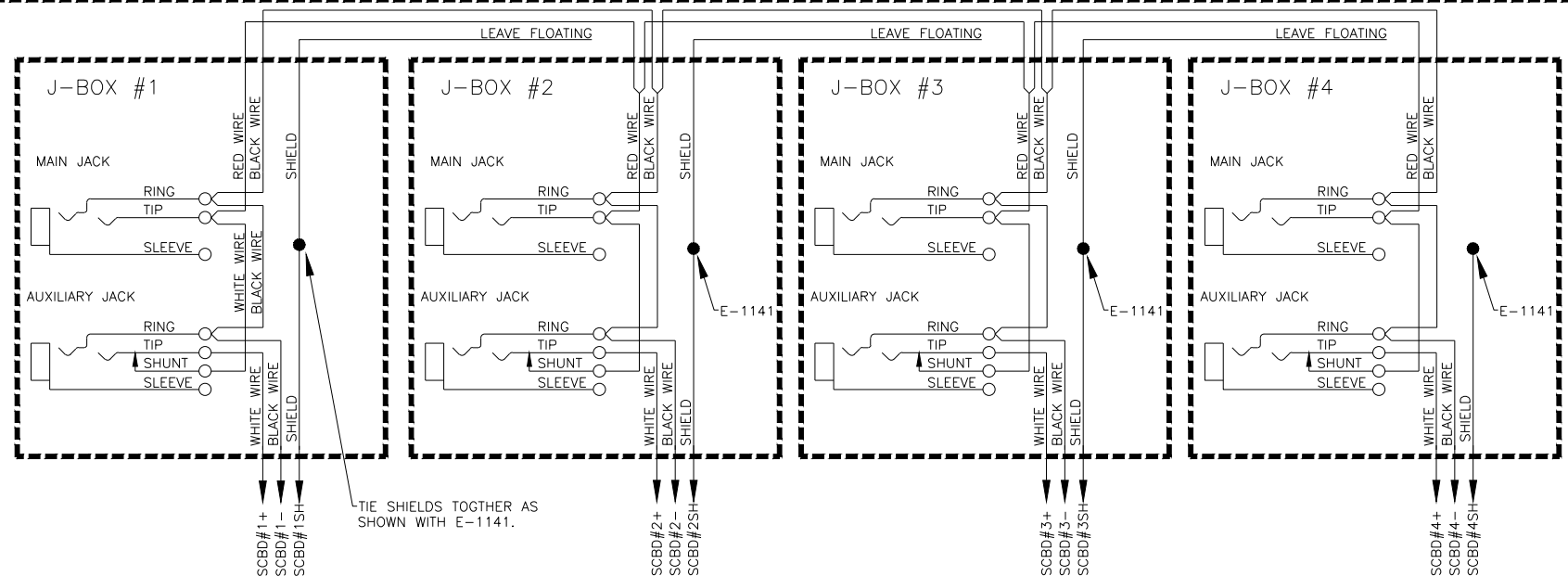

04	REV	JOB NO:	DATE: 24 JAN 00
04	P1196	R-01-A	125417

DETAIL "A"

RECOMMENDED MAXIMUM CABLE LENGTH WITH ONE RUN AS SHOWN = 2000'

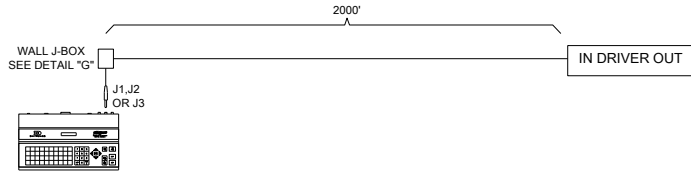

DETAIL "B"

RECOMMENDED MAXIMUM CABLE LENGTH WITH COMBINATION OF TWO RUNS FROM EITHER THE ALL SPORT 5000 OUTPUT OR ONE OUTPUT WITH 6 DRIVERS, REDRIVE CIRCUIT AS SHOWN = 2000' MAXIMUM REDRIVES ALLOWED: 6 FOR CLOCK DISPLAYS ALL LOCATED WITHIN THE SAME AREA, I.E. STADIUM OR ARENA

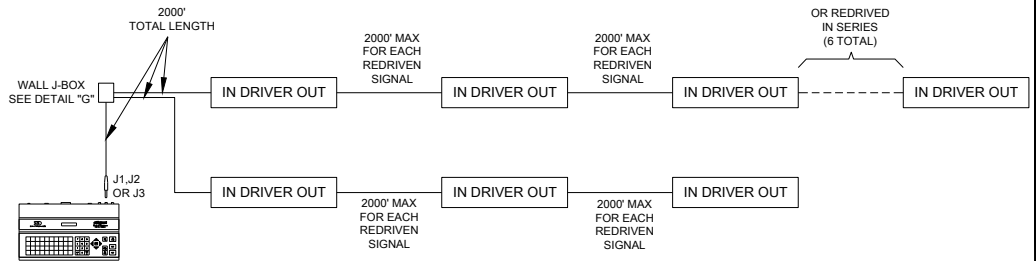

DETAIL "C"

RECOMMENDED MAXIMUM CABLE LENGTH WITH FROM EITHER THE ALL SPORT 5000 OUTPUT OR DRIVER REDRIVE CIRCUIT AS SHOWN = 2000' MAXIMUM REDRIVES ALLOWED: TO ANY NUMBER OF DEVICES WHILE UTILIZING SIGNAL IN/OUT REDRIVE FOR LOCKER ROOM CLOCK ONLY

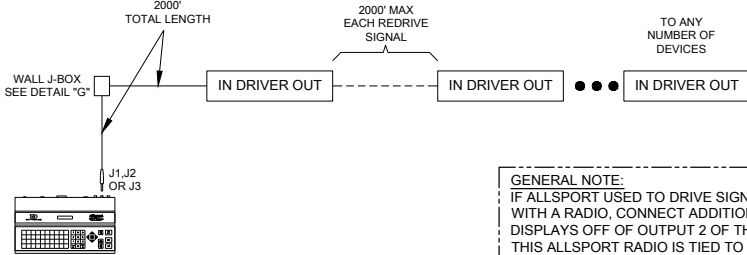

GENERAL NOTE:
IF ALLSPORT USED TO DRIVE SIGNAL IS EQUIPPED WITH A RADIO, CONNECT ADDITIONAL HARD WIRED DISPLAYS OFF OF OUTPUT 2 OF THE ALLSPORT. THIS ALLSPORT RADIO IS TIED TO OUTPUT 1. SO ADDITIONAL LOADS TO OUTPUT 1 MUST BE LIMITED.

DETAIL "D"

RECOMMENDED MAXIMUM PARALLEL LOADS ON REDRIVE CIRCUIT OR ALL SPORT 5000 OUTPUT = 6 PARALLEL LOADS

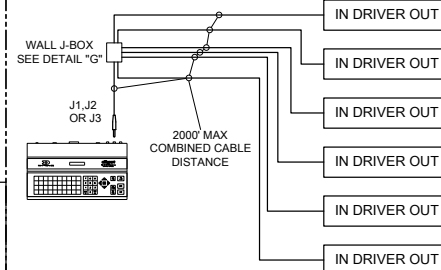

DETAIL "G"

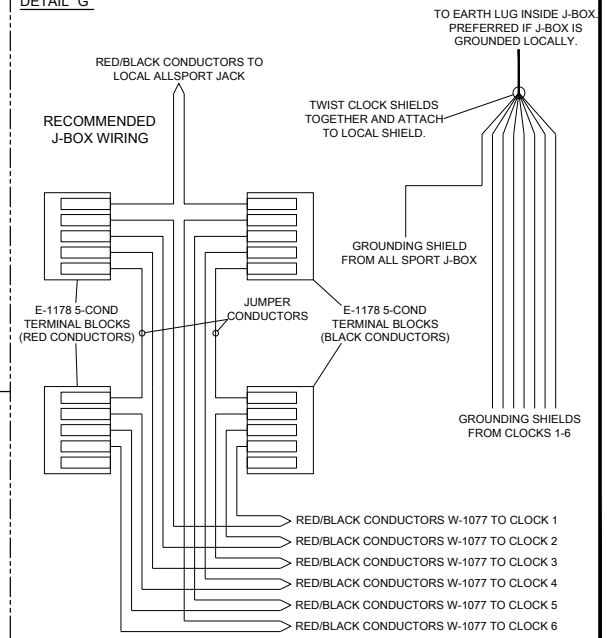

DETAIL "E"

RECOMMENDED MAXIMUM PARALLEL LOADS ON REDRIVE CIRCUIT OR ALL SPORT 5000 OUTPUT = 6 PARALLEL LOADS FOR CLUSTERED DISPLAYS IN THE SAME STADIUM/ARENA

SIGNAL TO MULTI DRIVER DISPLAYS SHOULD ALWAYS TERMINATE TO THE CLOCK SECTION UNLESS APPROVED BY ENGINEER

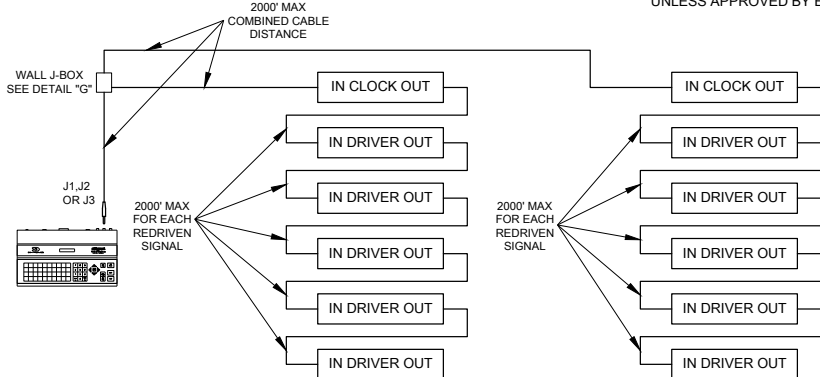

DETAIL "F"

RECOMMENDED MAXIMUM PARALLEL LOADS ON ALL SPORT 5000 OUTPUT = 6 SERIES LOADS

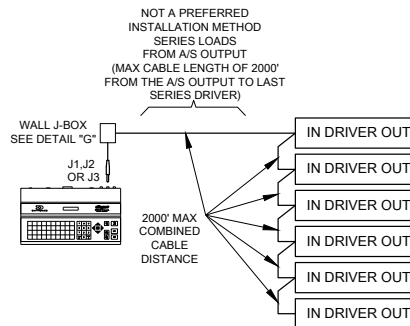

REV 03	DATE: 18 OCT 21	ADDED J-BOX DETAIL "G". SWAPPED CONTENTS OF DETAIL "E" AND DETAIL "F". ADDED A WALL J-BOX IN EACH DETAIL.	BY: TJP
REV 02	DATE: 20 APR 17	UPDATED DETAIL B AND D ADDED DETAIL C, E & F	BY: MTR

THE CONCEPTS EXPRESSED AND DETAILS SHOWN ON THIS DRAWING ARE CONFIDENTIAL AND PROPRIETARY. DO NOT REPRODUCE BY ANY MEANS WITHOUT THE EXPRESS WRITTEN CONSENT OF DAKTRONICS, INC. OR ITS WHOLLY OWNED SUBSIDIARIES. COPYRIGHT 2017 DAKTRONICS, INC. (USA)

THIRD ANGLE PROJECTION

PROJECT:	TITLE: ALL SPORT 5000 CURRENT LOOP OUTPUT SPECIFICATIONS		
DATE:	26 FEB 00	DIM UNITS: INCHES [MILLIMETERS]	SHEET REV
SCALE:	DO NOT SCALE DRAWING		
DESIGN:	JOB NO. P1196	FUNC. TYPE SIZE R. 01 - B	128429

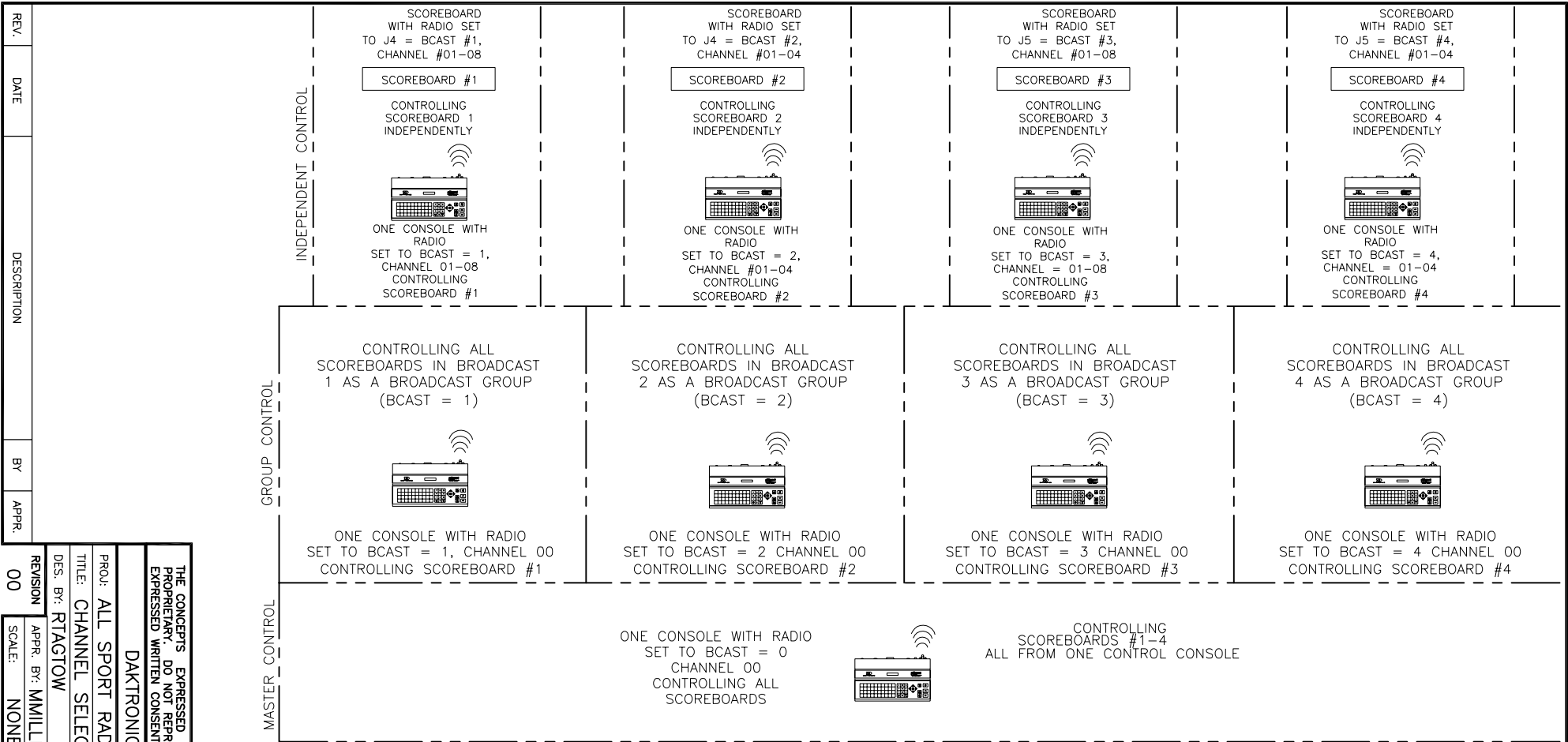

ADVANCED SETUP CONFIGURATIONS: INDEPENDENT SCOREBOARDS, GROUPED SCOREBOARDS, OR OVERALL MASTER CONTROLLED SCOREBOARDS.

A TYPICAL SCENARIO FOR THIS SETUP IS A BASKETBALL COURT THAT CAN BE RUN IN FULL COURT AND HALF COURT SETUP. THE INFORMATION BELOW WILL APPLY TO ANY SET OF SCOREBOARDS THAT NEED TO HAVE MULTIPLE CONTROL OPTIONS.

EACH SCOREBOARD RADIO RECEIVER WILL NEED TO BE SETUP; THERE ARE 4 BROADCAST GROUPS THAT CAN BE USED, BROADCAST 1 AND 3 CAN USE UP TO 8 CHANNELS (1-8), BROADCAST 2 AND 4 CAN USE UP TO 4 CHANNELS (1-4). J4 AND J5 ARE USED TO SELECT THE BROADCAST GROUP. J4 IS USED TO SELECT BROADCAST GROUPS 1 AND 2. J5 IS USED TO SELECT BROADCAST GROUP 3 AND 4. USE THE ROTARY DIAL ON THE RADIO TO SELECT THE CHANNEL. REFER TO DRAWING 1110-R01A-203543 OR 1110-R01A-203542 FOR BROADCAST AND CHANNEL SETTING INSTRUCTIONS.

FOR ALL SCOREBOARDS IN ONE BROADCAST GROUP, SET J4 OR J5 OF THE RADIO TO THE DESIRED BROADCAST GROUP (1-4) AND SET THE CHANNEL NUMBER TO THE CORRESPONDING SCOREBOARD CHANNEL. IT MAY BE NECESSARY TO CHANGE THE CHANNEL ON THE SCOREBOARD, IF A CHANNEL OTHER THAN WHAT IS SET IS NEEDED (REFER TO DRAWING 1110-R01A-203543 OR 1110-R01A-203542 FOR SCOREBOARD CHANNEL SETTING INSTRUCTIONS). EACH RADIO WITHIN THE SAME BROADCAST GROUP MUST BE SET TO A DIFFERENT CHANNEL NUMBER FROM 1-8 FOR GROUPS 1 AND 3 (CHANNELS 1-4 FOR BROADCAST GROUPS 2 AND 4).

MASTER CONTROL

TO RUN ALL SCOREBOARDS AT ONCE; SET THE CONTROL CONSOLE TO BCAST = 0, CHANNEL = 00.

GROUP CONTROL

TO RUN ALL SCOREBOARDS IN BROADCAST GROUP 1 AT ONCE SET THE CONTROL CONSOLE TO BCAST = 1, CHANNEL = 00
TO RUN ALL SCOREBOARDS IN BROADCAST GROUP 2 AT ONCE SET THE CONTROL CONSOLE TO BCAST = 2, CHANNEL = 00
TO RUN ALL SCOREBOARDS IN BROADCAST GROUP 3 AT ONCE SET THE CONTROL CONSOLE TO BCAST = 3, CHANNEL = 00
TO RUN ALL SCOREBOARDS IN BROADCAST GROUP 4 AT ONCE SET THE CONTROL CONSOLE TO BCAST = 4, CHANNEL = 00

INDEPENDENT CONTROL

TO RUN EACH SCOREBOARD INDEPENDENTLY, SET THE CONTROL CONSOLE TO THE APPROPRIATE BROADCAST GROUP (BCAST = 1-4), AND THEN SET THE CHANNEL TO THE SCOREBOARD CHANNEL. EX. TO RUN SCOREBOARD #3 IN THE SETUP ILLUSTRATED ABOVE, SET THE CONTROL CONSOLE TO BCAST = 3, CHANNEL = 01.

THE CONCEPTS EXPRESSED AND DETAILS SHOWN ON THIS DRAWING ARE CONFIDENTIAL AND PROPRIETARY. DO NOT REPRODUCE BY ANY MEANS, INCLUDING ELECTRONICALLY WITHOUT THE EXPRESSED WRITTEN CONSENT OF DAKTRONICS, INC. COPYRIGHT 2002 DAKTRONICS, INC.

PROJ: ALL SPORT RADIO
TITLE: CHANNEL SELECTION; MULTIPLE BROADCAST GROUP, GEN IN
DES. BY: RTAGTOW
DRAWN BY: RTAGTOW
DATE: 26 JAN 04

DAKTRONICS, INC. BROOKINGS, SD 57006

REVISION 00
APPR. BY: MILLER
SCALE: NONE

1110-R01A-203113

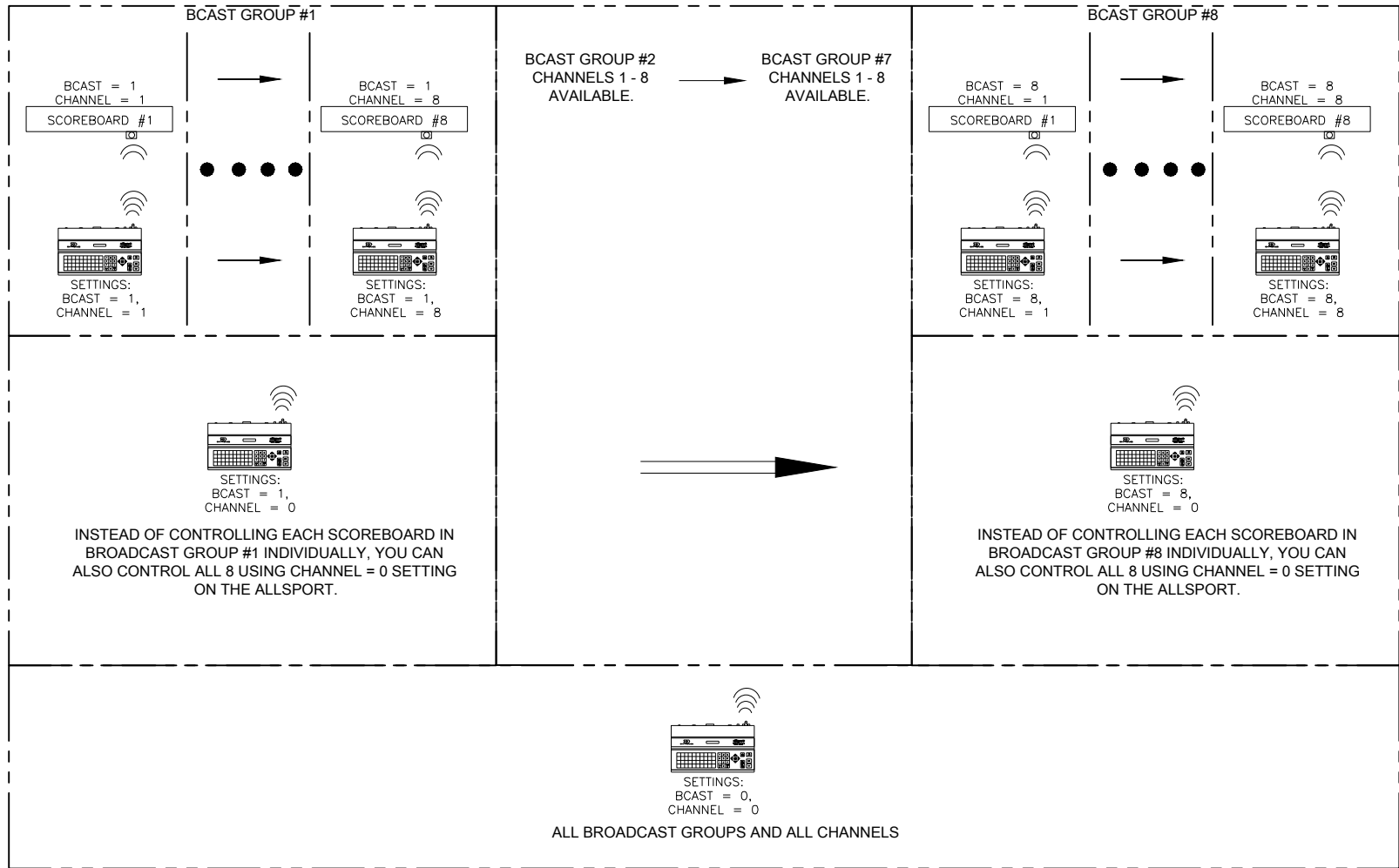

INSTEAD OF CONTROLLING EACH SCOREBOARD IN BROADCAST GROUP #1 INDIVIDUALLY, YOU CAN ALSO CONTROL ALL 8 USING CHANNEL = 0 SETTING ON THE ALLSPORT.

INSTEAD OF CONTROLLING EACH SCOREBOARD IN BROADCAST GROUP #8 INDIVIDUALLY, YOU CAN ALSO CONTROL ALL 8 USING CHANNEL = 0 SETTING ON THE ALLSPORT.

ALL BROADCAST GROUPS AND ALL CHANNELS

- ADVANCED SETUP CONFIGURATIONS:
- 1 CONSOLE HAS 64 CHANNELS. USING IT AS A MASTER CONTROL:
 - *RUNS ALL SCOREBOARDS AT ONCE
 - *CONSOLE RADIO SETTING: BCAST = 0, CHANNEL = 0
 - 1 CONSOLE CAN ALSO CONTROL JUST 8 CHANNELS IN A SELECTED GROUP. GROUP CONTROL:
 - *RUNS ALL SCOREBOARDS ASSIGNED TO BCAST X AND CHANNELS 1 - 8. X COULD BE BCAST GROUP 1, OR 2, OR... 8
 - *CONSOLE RADIO SETTING: BCAST = X, CHANNEL = 0. X COULD BE BCAST GROUP 1, OR 2, OR... 8
 - 1 CONSOLE CAN ALSO CONTROL JUST 1 CHANNEL IN A SELECTED GROUP. INDIVIDUAL CONTROL:
 - *RUNS ALL SCOREBOARDS ASSIGNED TO BCAST X AND CHANNEL Y. X COULD BE BCAST GROUP 1, OR 2, OR... 8. Y COULD BE CHANNEL 1, OR 2, OR... 8
 - *CONSOLE RADIO SETTING: BCAST = X, CHANNEL = Y. X COULD BE BCAST GROUP 1, OR 2, OR... 8. Y COULD BE CHANNEL 1, OR 2, OR... 8

NOTE: TO FIND THE SCOREBOARD RADIO SETTING:

- MAKE SURE THE CONSOLE IS TURNED OFF.
- CYCLE POWER TO THE SCOREBOARD
- WATCH THE DIGITS AS THE SCOREBOARD BOOTS UP. YOU WILL SEE A B X AND C Y APPEAR ON THE DIGITS.

<p>DAKTRONICS, INC. BROOKINGS, SD 57006</p>		<p>PROJ: RADIO LINK, GEN VI</p>	
		<p>TITLE: INSTALLATION DETAILS, GEN VI CHANNEL SELECTION GUIDE</p>	
<p>DESIGN: JOSE</p>		<p>DRAWN: MILLER</p>	
<p>SCALE: NONE</p>		<p>DATE: 14 AUG 12</p>	
<p>SHEET</p>	<p>REV</p>	<p>JOB NO.</p>	<p>FUNC-TYPE-SIZE</p>
<p>00</p>	<p>P 110</p>	<p>F - 01 - A</p>	<p>1109870</p>

THE CONCEPTS EXPRESSED AND DETAILS SHOWN ON THIS DRAWING ARE CONFIDENTIAL AND PROPRIETARY. DO NOT REPRODUCE BY ANY MEANS WITHOUT THE EXPRESSED WRITTEN CONSENT OF DAKTRONICS, INC. COPYRIGHT 2012 DAKTRONICS, INC.

B Sport Inserts

Refer to **Resources (p. 2)** for information regarding how to read the drawing number.

Reference Drawings:

Insert, Basketball, LL-2433.....	DWG-120121
Insert; LL-2435 A/S 5000, Wrestling.....	DWG-124701
Insert; LL-2434 A/S 5000, Volleyball	DWG-125055
Insert; LL-2441 A/S 5000, Team Name	DWG-125290
Insert; LL-2475 A/S 5000, Segment Timer.....	DWG-129357

This page intentionally left blank.

07	30 MAR 04	ADDED CODE 1301 MATSIDE	RDS
06	24 FEB 04	UPDATED REVISION TEXT TO MATCH SPEC DWG	DUU
05	19 FEB 04	ADDED CLEAR TEAM FOULS KEY	DUU
REV.	DATE	DESCRIPTION	BY
			APPR.

PROJ:	ALL SPORT 5000 SERIES CONSOLE
TITLE:	INSERT, BASKETBALL, LL-2433
DES. BY:	AVB
APPR. BY:	A VANBEMMEL
DATE:	11 AUG 99
REVISION	07
SCALE:	1=1
1196-E07A-120121	

LL-2433 REV 07

BASKETBALL

CODE	TYPE
1101	PLAYER-FOUL
1102	FOUL-PLAYER
1103	SERIES 3000
1104	SERIES 2500
1105	PLYR/FL/PTS
1301	MATSIDE
1401	HKY W/O SOG
1402	HKY W/SOG

PLACE CODE LABEL HERE
ENTER THIS CODE NUMBER

HOME

GUEST

RECALL SHOT TIME SET SHOT TIME TIME OUT ON/OFF

IN GAME OUT OF GAME

DELETE PLAYER BLANK PLAYER FOUL

CLEAR TEAM FOULS PERIOD +1

DAKTRONICS, INC. BROOKINGS, SD 57006

REV 04	DATE: 17 MAR 06	ADDED RECOVERY TIME KEYS	BY: DUU
REV 03	DATE: 26 JULY 00	ADDED CODE 3105 PLYR/FL/PTS	BY: EB
REV 02	DATE: 27 DEC 99	ADDED CODE LABEL LOCATION	BY: EB
REV 01	DATE: 06 DEC 99	ADDED CODE NUMBERS	BY: EB

WRESTLING

CODE	TYPE
3101	PLAYER-FOUL
3102	FOUL-PLAYER
3103	SERIES 3000
3104	SERIES 2500
3105	PLYR/FL/PTS
3304	MATSIDE JR

h0-2435 REV 04

PLACE CODE LABEL HERE
ENTER THIS CODE NUMBER

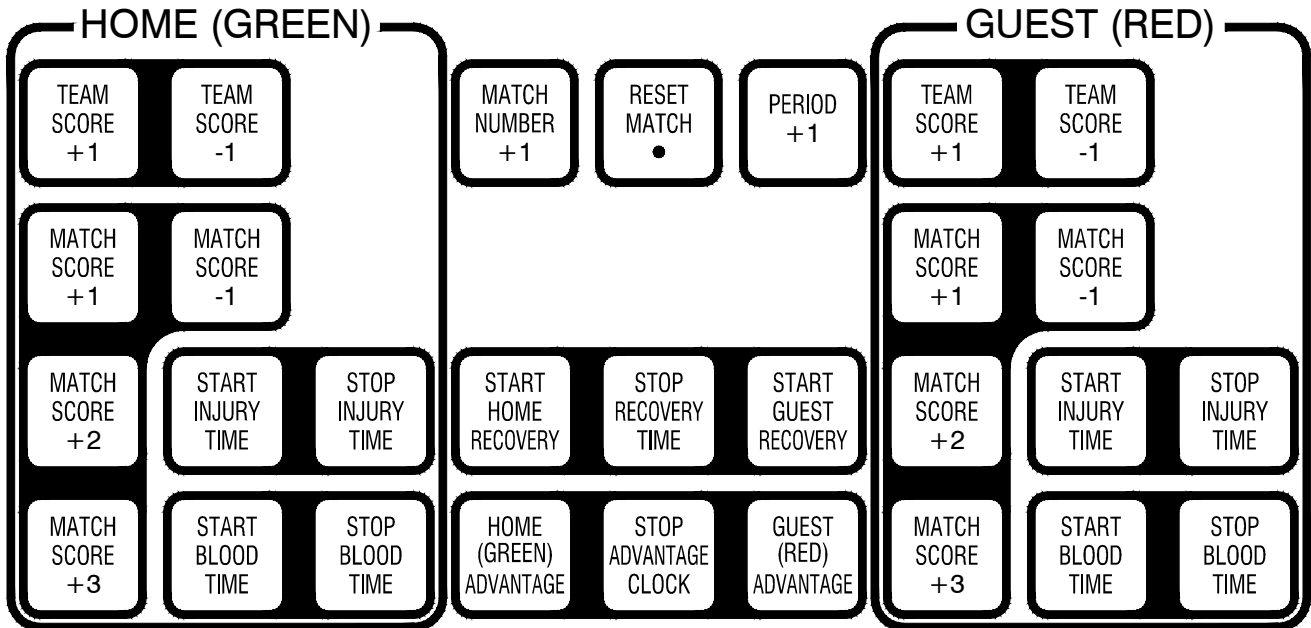

		DAKTRONICS, INC.	
BROOKINGS, SD 57006		BROOKINGS, SD 57006	
DO NOT SCALE DRAWING			
Prod: ALL SPORT 5000 SERIES CONSOLE			
Title: INSERT: LL-2435 A/S 5000, WRESTLING			
DESIGN: AVB		DRAWN: A VANBEMMEL	
SCALE: 1 = 1		DATE: 19 NOV 99	
SHEET		JOB NO:	
REV 04	P1196	FUNC-TYPE-SIZE	E-07-A
			124701

THE CONCEPTS EXPRESSED AND DETAILS SHOWN ON THIS DRAWING ARE CONFIDENTIAL AND PROPRIETARY. DO NOT REPRODUCE BY ANY MEANS WITHOUT THE EXPRESSED WRITTEN CONSENT OF DAKTRONICS, INC. COPYRIGHT 2010 DAKTRONICS, INC.

REV 02	DATE: 26 JULY 00	ADDED CODE 2105 PLYR/FL/PTS	BY: EB
REV 03	DATE: 30 MAR 03	ADDED CODE 2301 MATSIDE	BY: RBS
REV 04	DATE: 09 FEB 10	ADDED CODE 2301 MATSIDE	BY: DUU
REV 05	DATE: 16 JAN 12	CHANGED GAMES TEXT TO SET	BY: DUU
REV 06	DATE:	ADDED "SUBS +1" KEYS TO HOME AND GUEST SECTIONS. EDITED SECTION OUTLINES	BY:

LL-2434 REV 05

VOLLEYBALL

CODE	TYPE
2101	MATCH/GAME
2111	GAME
2103	SERIES 3000
2104	SERIES 2500
2105	PLYR/FL/PTS
2301	MATSIDE

PLACE CODE LABEL HERE
ENTER THIS CODE NUMBER

HOME

SCORE +1	SCORE -1	TIME OUT ◀
ACES +1	KILLS +1	SETS WON +1
BLOCKS +1	DIGS +1	SERVE ◀
PLAYER •	INDIV. SUB. •	MASS SUB. •

TIME OUT ON/OFF

IN GAME

OUT OF GAME

DELETE PLAYER

MATCH NUMBER +1

SET +1

GUEST

SCORE +1	SCORE -1	TIME OUT ▶
ACES +1	KILLS +1	SETS WON +1
BLOCKS +1	DIGS +1	SERVE ▶
PLAYER •	INDIV. SUB. •	MASS SUB. •

DAKTRONICS, INC.
BROOKINGS, SD 57006

DO NOT SCALE DRAWING

THE CONCEPTS EXPRESSED AND DETAILS SHOWN ON THIS DRAWING ARE CONFIDENTIAL AND PROPRIETARY. DO NOT REPRODUCE BY ANY MEANS WITHOUT THE EXPRESSED WRITTEN CONSENT OF DAKTRONICS, INC. COPYRIGHT 2010 DAKTRONICS, INC.

Proj: ALL SPORT 5000 SERIES CONSOLE

DESIGN: EB

SCALE: 1 = 1

SHEET: _____

REV: 05

JOB NO: P1196

DATE: 06 DEC 99

FUNC-TYPE-SIZE: E-07-A

125055

REV 01	DATE: 27 DEC 99	ADDED CODE LABEL LOCATION	BY: EB
--------	-----------------	---------------------------	--------

REV: 01 DATE: 11 FEB 08 ADDED "&" SYMBOL TO INSERT BY: JMC

LL-2441 R01

TEAM NAME

WIDTH				HEIGHT		FONT			
16 COLUMNS	32 COLUMNS	48 COLUMNS	64 COLUMNS	7 ROWS	8 ROWS	SINGLE STROKE	DOUBLE STROKE	& -	SHIFT
Q	W	E	R	T	Y	U	I	O	P
A	S	D	F	G	H	J	K	L	'
Z	X	C	V	B	N	M	,	.	SPACE

DAKTRONICS, INC.
 BROOKINGS, SD. 57006
 DO NOT SCALE DRAWING
 THE CONCEPTS EXPRESSED AND DETAILS SHOWN ON THIS DRAWING ARE CONFIDENTIAL AND PROPRIETARY. DO NOT REPRODUCE BY ANY MEANS WITHOUT THE EXPRESSED WRITTEN CONSENT OF DAKTRONICS, INC. COPYRIGHT 2010 DAKTRONICS, INC.

Proj: ALL SPORT 5000
 Title: INSERT: LL-2441 A/S 5000, TEAM NAME
 Design: EB DRAWN: E BRAVEK DATE: 13 DEC 99
 Scale: 1 = 1
 SHEET: 01 REV: P1196 JOB NO: E-07-A FUNC-TYPE-SIZE: 125290

LL-2475 REV 01

SEGMENT TIMER

ACCESS THROUGH MENU FROM WITHIN SPORT CODE

PRESS 

PRESS  UNTIL

DISPLAY MENU?

PRESS 

SEGMENT TIMER Y/N

PRESS 

DEDICATED SEGMENT TIMER

CODE 100

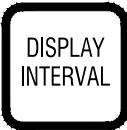
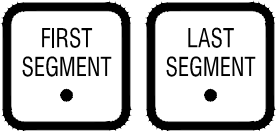

 **DAKTRONICS, INC.**
 BROOKINGS, SD 57006
 DO NOT SCALE DRAWING

THE CONCEPTS EXPRESSED AND DETAILS SHOWN ON THIS DRAWING ARE CONFIDENTIAL AND PROPRIETARY. DO NOT REPRODUCE BY ANY MEANS WITHOUT THE EXPRESSED WRITTEN CONSENT OF DAKTRONICS, INC. COPYRIGHT 2010 DAKTRONICS, INC.

Proj: ALL SPORT 5000
 TITLE: INSERT: LL-2475 A/S 5000, SEGMENT TIMER
 DESIGN: EB DRAWN: E BRAVEK DATE: 21 MAR 00
 SCALE: 1 = 1

REV	JOB NO:	FUNC-TYPE-SIZE	DATE:
01	P1196	E-07-A	21 MAR 00
SHEET			1
129357			

This page intentionally left blank.

C Sport Code Numbers

Model	Address	Basketball	Volleyball	Wrestling	Hockey	Football
BB-314	17	1105	2105	3105	4105	6105
BB-3101	17	1105	2105	3105	4105	6105
BB-3102	17	1105	2105	3105	4105	6105
BB-3103	17	1101, 1102 ¹	2101, 2111 ²	3101, 3102 ³		
BB-3104	17	1101, 1102 ¹	2101, 2111 ²	3101, 3102 ³		
BB-3105	17	1105	2105	3105	4105	6105
BB-3106	17	1105	2105	3105	4105	6105
BB-3107	17	1101, 1102 ¹	2101, 2111 ²	3101, 3102 ³		
BB-3108	17	1101, 1102 ¹	2101, 2111 ²	3101, 3102 ³		
BB-3114	1 + Col 5-8	All				All
BB-3115	1	All	All ⁴	All ⁴	All ⁴	All
BB-3121	17	1105	2105	3105	4105	6105
BB-3123	17,14	1105	2105	3105	4105	6105
BB-3124	17,14	1105	2105	3105	4105	6105
BB-3125	17	1101, 1102 ¹	2101, 2111 ²	3101, 3102 ³		
BB-3126	17	1101, 1102 ¹	2101, 2111 ²	3101, 3102 ³		
BB-3142	17	1101	2101	3101	4105	6105
BB-3145	17	1101	2101	3101	4105	6105
BB-3146	17	1101	2101	3101	4105	6105
BB-3147	17	1101	2101	3101	4105	6105
SD-3101	23,24,25,26	1101, 1102	2101	3101	4401	
SD-3102	23,24,25,26	1101, 1102	2101	3101	4401	
SD-3103	23, 24, 25, 26, 27, 28	1101, 1102	2101	3101	4401	
SD-3106	15		2105	3105	4105	
ST-3001	17	1101	2101	3101	4105	6105
TI-3031	1 + Col 1-4	All	All	All	All	
TI-3103	1	All	All	All	All	All

Notes:

1. Code 1101 is Player-Foul and code 1102 is Foul-Player
2. Code 2101 is Game Number & Match Number and code 2111 is Game Number only
3. Code 3101 is Match Number and code 3102 is Advantage Time
4. Game Clock only

This page intentionally left blank.

D Quick Reference

All Sport 5500 Standard Keys

Refer to **Standard Keys (p. 6)** for detailed operating instructions.

Start/Stop Clock

- **<START>** and **<STOP>** control the function of the main clock.
- The green LED on the **<START>** button is illuminated when the clock is running.

Horn

- **<HORN>** sounds the main horn. The horn sounds for as long as the key is pressed.
- **<AUTO HORN>** sets the horn to automatically sound when a period end is reached. The yellow **<HORN>** LED is illuminated when the auto horn setting is ON.

Clock Direction

- **<COUNT UP/DOWN>** sets the direction of the main clock. The clock direction is shown in the upper right corner of the LCD.
- This key is disabled while the clock is running.

Set Main Clock

- The first press of the **<SET MAIN CLOCK>** edits the current main clock value.
- Press the **<SET MAIN CLOCK>** repeatedly to edit the configured period, break, and overtime length.
- Press **<ENTER>** at any of the displayed clock values to load that value into the main clock.
- This key is disabled while the clock is running.

Edit Key

- **<EDIT>** is used to edit score or statistic values. Press **<EDIT>** followed by the desired button to be edited. Refer to the specific sport section for all edit key functions.

Segment Timer

Refer to **Section 3: Segment Timer Operation (p. 20)** for detailed operating instructions.

First and Last Segment

- **<FIRST SEGMENT •>** and **<LAST SEGMENT •>** set the range of segments to be used.

Auto Stop

- **<AUTO STOP>** sets the console to stop at the end of each segment or at the end of the last segment.

Current Segment

- **<CURRENT SEGMENT +1>** increments the current segment value

Reset

- **<RESET CURRENT SEGMENT>** sets the segment time to the current segment value and stops the clock.
- **<RESET TO FIRST SEG>** sets the segment number and time to the first segment value.
- This key is disabled while the clock is running.

Interval

- **<INTERVAL TIME •>** sets the interval time.
- **<DISPLAY INTERVAL>** sets the console to display interval time between segments.

Segment Time Editing

- **<SEG. NO. • TIME •>** allows the time for a specified segment to be edited. Once the segment time is edited, pressing the up or down arrow key scrolls through the segment times and allows any other segments to be edited.
- **<COPY RANGE •>** copies a time value to a range of segments.

Edit Key Function

- Press **<EDIT>** followed by **<CURRENT SEGMENT +1>** to edit the current segment value.

Basketball

Refer to **Section 4: Basketball Operation (p. 25)** for detailed operating instructions.

Start-Up

- Turn the Power Switch **ON**.
- At the **Resume Game? Y/N** prompt, press **<ENTER /YES>** to resume the game where last shut off, or press **<Clear/NO>** to enter a new sport code number.

Team Score

- **<SCORE +1>**, **<SCORE +2>**, **<SCORE +3>**, and **<SCORE -1>** increment and decrement the team score.
- The console may ask for a player number depending on the **Team Score – Update Player** setting in the **EDIT SETTINGS** menu.

Team Fouls

- **<TEAM FOULS +1>** and **<TEAM FOULS -1>** increment and decrement the total fouls.
- **<BLANK PLAYER FOUL>** blanks the displayed player-foul digits.
- The console may ask for a player number depending on the **Team Score – Update Player** setting in the **EDIT SETTINGS** menu.

Time Out

- **<TIME OUT>** displays the number of full (1st press) or partial (2nd press) timeouts (if applicable). Press **<ENTER>** to take a time out for the selected team.
- **<TIME OUT ON/OFF>** selects a full (1st press) or partial (2nd press) time out and starts the time out clock.
- The time out clock may be displayed on the scoreboard depending on the **Time Outs – Show on Main** setting in the **EDIT SETTINGS** menu.

Possession

- **<POSS>** turns the possession indicators on or off for the respective team.

Bonus

- **<BONUS>** turns the 1-on-1 bonus indicators or 2-shot bonus indicators on or off.

Period

- **<PERIOD +1>** increments the period value.

Shot Clock Time

- **<SET SHOT TIME>** changes the current value of the shot clock timer. Pressing **<SET SHOT TIME>** a second time allows edit of the reset value of the shot clock timer.

Player Roster Keys

- **<PLAYER>** selects the player number for statistics edit. Pressing **<IN GAME>** or **<OUT OF GAME>** within the player statistics edit screen changes the status of the player selected. Press the arrow keys to edit the foul or points values for the chosen player. Press the up or down arrow keys to move to a different player.
- **<DELETE PLAYER>** deletes the selected player from the roster.

Player Substitution

- **<INDIV. SUB>** substitutes a player currently out of the game for an in-game player.
- **<MASS SUB>** substitutes five players who are currently out of the game for all of the in-game players.

Edit Key Function

- Press **<EDIT>** followed by any of the following keys to edit their respective values: **<TIME OUT>**, **<TIME OUT ON/OFF>**, **<SCORE +1>**, **<SCORE +2>**, **<SCORE +3>**, **<SCORE -1>**, **<TEAM FOULS +1>**, and **<PERIOD +1>**

Volleyball

Refer to **Section 5: Volleyball Operation (p. 40)** for detailed operating instructions.

Start-Up

- Turn the Power Switch **ON**.
- At the **Resume Game? Y/N** prompt, press **<ENTER /YES>** to resume the game where last shut off, or press **<Clear/NO>** to enter a new sport code number.

Team Score

- **<SCORE +1>** and **<SCORE -1>** increment and decrement the team score.

Sets Won

- **<SETS WON +1>** increments the number of games won for the respective team.

Serve

- **<SERVE>** turns the serve indicators on or off for the respective team.

Set and Match Number

- **<SETS +1>** increments the game number. Game scores will be reset to zero for the start of the next game. Press **<EDIT><SETS +1>** to recover previous game scores.
- **<MATCH NUMBER +1>** increments the match number.

Aces, Blocks, Kills, Digs

- **<ACES +1>**, **<BLOCKS +1>**, **<KILLS +1>**, and **<DIGS +1>** increment their respective team totals.
- The console may ask for a player number depending on the **Team Stats – Update Player** setting in the **EDIT SETTINGS** menu.
- Team statistics will be displayed based on the setting of **User Defined** settings for scoreboards displaying two of the stats.

Time Out

- **<TIME OUT>** displays the number of full (1st press) or partial (2nd press) timeouts (if applicable). Press **<ENTER>** to take a time out for the selected team.
- **<TIME OUT ON/OFF>** selects a full (1st press) or partial (2nd press) time out and starts the time out clock.
- The time out clock may be displayed on the scoreboard depending on the **Time Outs – Show on Main** setting in the **EDIT SETTINGS** menu.

Player Roster Keys

- **<PLAYER>** selects the player number for statistics edit. Pressing **<IN GAME>** or **<OUT OF GAME>** within the player statistics edit screen changes the status of the player selected. Press the left and right arrow keys to edit the aces, kills, blocks, and digs for the selected player. Press up or down arrow keys to move to a different player.
- **<DELETE PLAYER>** deletes the selected player from the roster.

Player Substitution

- **<INDIV. SUB>** substitutes a player currently out of the game for an in-game player.
- **<MASS SUB>** substitutes six players who are currently out of the game for all of the in-game players.
- **<SUBS +1>** increments the number of substitutions taken.

Edit Key Function

- Press **<EDIT>** followed by any of the following keys to edit their respective values: **<SCORE +1>**, **<SCORE -1>**, **<ACES +1>**, **<BLOCKS +1>**, **<KILLS +1>**, **<DIGS +1>**, **<TIME OUT>**, **<TIME OUT ON/OFF>**, **<SETS WON +1>**, **<MATCH NUMBER +1>**, **<SETS +1>**, and **<SUBS +1>**
- Pressing the up or down arrow keys after pressing **<EDIT><SCORE+1>** scrolls through the game scores for the selected team.

Wrestling

Refer to **Section 6: Wrestling Operation (p. 53)** for detailed operating instructions.

Start-Up

- Turn the Power Switch **ON**.
- At the **Resume Game? Y/N** prompt, press **<ENTER /YES>** to resume the game where last shut off, or press **<Clear/NO>** to enter a new sport code number.

Team Score

- **<SCORE +1>** and **<SCORE -1>** increment and decrement the team score.
- **<MATCH SCORE +1>**, **<MATCH SCORE +2>**, **<MATCH SCORE +3>**, and **<MATCH SCORE -1>** increment and decrement the match score.

Match Number

- **<MATCH NUMBER +1>** increments the match number.
- **<RESET MATCH>** resets the match score and sets match time to the configured Period length.

Period

- **<PERIOD +1>** increments the period number.

Injury and Blood Time

- **<START INJURY TIME>**, **<STOP INJURY TIME>**, **<START BLOOD TIME>**, and **<STOP BLOOD TIME>** control the injury and blood time out timers.
- The Blood and Injury time can be displayed on the scoreboard using the **Blood/Injury Show on Main** setting in the **EDIT SETTINGS** menu

Advantage Time

- **<HOME (GREEN) ADVANTAGE>**, **<GUEST (RED) ADVANTAGE>**, and **<STOP ADVANTAGE CLOCK>** are used to control the advantage timer. Press the team advantage key to set the clock to decrease the opposing team advantage time or increase the selected team advantage time. Press the **<STOP ADVANTAGE CLOCK>** to stop the advantage timer.

Edit Key Function

- Press **<EDIT>** followed by any of the following keys to edit their respective values: **<TEAM SCORE +1>**, **<TEAM SCORE -1>**, **<MATCH SCORE +1>**, **<MATCH SCORE -1>**, **<MATCH NUMBER>**, **<PERIOD +1>**, **<TIME OUT>**, and **<TIME OUT ON/OFF>**
- Pressing **<EDIT>** and **<START INJURY TIME>**, **<STOP INJURY TIME>**, **<START BLOOD TIME>**, or **<STOP BLOOD TIME>** while the time out clock is stopped will edit the current value of the respective timer.

This page intentionally left blank.

E Supplementary Documents

Supplementary Documents
Scoreboard Driver Bootload Update Procedure.....**ED-18728**

This page intentionally left blank.

Some scoreboard drivers feature a “bootloader” that allows firmware updates to be performed in the field using a computer and an All Sport 5000 or an All Sport 5500 (ColorSmart) control console. The console acts as a signal converter between the computer and the scoreboard network.

Requirements

Software Versions

- The All Sport 5000 must have software version 4.1.5 or later.
- The All Sport 5500 must have software version 1.0.5 or later.
- The 16 column MultiCast driver (0P-1388-0100) must have software version 1.3 or later.
- The Gyrus driver (0A-1782-0100) must have software version 1.3 or later. Also note:
 - Gyrus driver address must be non-zero.
 - Gyrus driver will not bootload if running Power-On Diagnostics (FF).
 - Gyrus drivers must be running from Multi-Drop protocol and will not bootload while running in any of the other following protocols:
 - Multi-Line
 - Colorado Timing Systems
 - Omega

Equipment

- Computer with internet access and a 9-pin serial port [or USB-to-Serial adaptor (part # A-2221)]
- 9-pin to 9-pin serial cable (part # W-1267) or 9-pin to 25-pin serial cable (part # W-1249)

Instructions

1. Make sure that the All Sport console has a version of firmware that supports bootloading (see **Requirements** above). If it does not, contact customer service to request an All Sport PROM update.
2. Make sure the scoreboard driver has a version of firmware that supports bootloading by cycling the scoreboard power and observing the power up sequence. An “rx.x” message will be displayed, where “x.x” is the version number. If the version number is under 1.3, the drivers will have to be updated with a programming board or exchanged for newer versions.
3. Download the DakLoader program and the Field Update file:
 - a. On a computer with internet access, open a web browser and go to: http://dakfiles.daktronics.com/downloads/Sports_Products/Bootloader/
 - b. Click on the “DakLoader2.exe” file, and **Save** it to the Desktop.
 - c. Click on the specific “Driver Update Files” directory, either “MultiCast” or “Gyrus”.
 - d. Click on the “16 col driver” directory.
 - e. Click on the compressed “.zip” file, and **Save** it to the Desktop as well.
 - **MultiCast Drivers:** “ED-16327_Mcast16.zip”
 - **Gyrus Drivers:** “DD-2929930_Gyrus_vX_Y.zip” (X_Y = latest version number)
 - f. Unzip the downloaded file to obtain the “.fud” (**Field UpDate**) file.

NOTE FOR GYRUS DRIVERS:

The proper Field Update File to unzip depends on the firmware of the All Sport 5000 console. Power on the console, and identify the firmware version during boot-up.

- **Version 4.1.5:** Unzip the FUD file in the “AllSport_v4_1_5_compatible” folder.
- **Version 4.1.6+:** Unzip the FUD file in the “AllSport_v4_1_6_plus_compatible” folder.

4. Enter code "0001" into the All Sport console. Remove any sport insert over the console's keypad, and press <T> or <G> to send rotating rows or rotating columns test command to the scoreboard.
5. Connect the computer to the All Sport 5000 or 5500:
 - If the All Sport console has the **J5 COMPUTER PORT** option loaded, connect this port to the computer using a standard 9-pin serial cable.
 - If the All Sport console has the **J6 I/O PORT** option loaded, connect this port to the computer using a 9-pin to 25-pin serial cable.

Note: If the computer does not have a 9-pin serial port, a USB-to-serial adaptor will be required.

6. Open the DakLoader2 program that was saved to the Desktop in **step 3b**.
7. Click on the **Communications** menu, and verify the appropriate **COM#** port is selected:

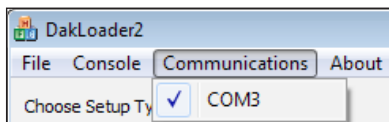

8. Select **Other AS5500**, and then click the [...] button to browse to the Field Update file that was extracted from the zip file in **step 3f**:

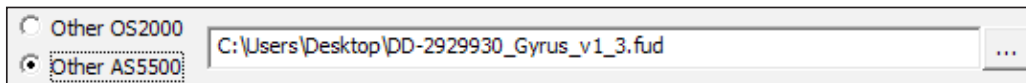

9. Click **Update**. The *Status* window will now show: "Waiting for the update process to start on the AllSport."

10. Start the update process on the All Sport console:

- a. On the All Sport console, press <MENU> and then press <ENTER> to select a New Code. Enter a valid sport code other than 0001.
- b. Press <MENU> again. Use the arrow keys to navigate to "MENU- MAIN ENTER DISPLAY MENU?" and then press <ENTER>.
- c. Use the arrow keys to navigate to "MENU-DISPLAY RUN DOWNLOAD Y/N?" and then press <ENTER>.
- d. The All Sport LCD should immediately show "HEADER RECEIVED WAIT FOR ERASE", and the *Status* window in the DakLoader program should show "Sending field update..."

MENU- MAIN
NEW CODE?

MENU- MAIN ENTER
DISPLAY MENU?

MENU-DISPLAY RUN
DOWNLOAD Y/N?

HEADER RECEIVED
WAIT FOR ERASE

TIMED OUT
RETRY Y/N?

Note: If the process does not start, check the serial cable connection and the COM port selection in the DakLoader program. The All Sport will time out after 20 seconds and allow the process to be tried again.

- e. There will be a delay of a few seconds while the All Sport sends a command to the scoreboard network instructing all drivers to erase their firmware. Both the All Sport and the DakLoader program will then show the progress of the update:

RECEIVING FILE
BLOCK # 0001

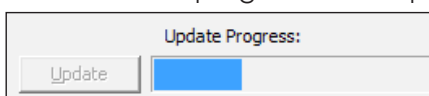

11. Monitor the status of the update on the scoreboard:

- a. Supported drivers will display the status codes in the table below on their first 2 columns (typically the first 2 clock digits or Home/Guest score digits if there is no clock):

Status Code	Meaning
bA	Bootload mode entered, looking for an active communication channel
bB	Communication channel found, waiting for Download Firmware command
bC	Download Firmware command received, erasing memory
bD	Memory erased, receiving new firmware file
bE	Bootload successful, waiting for command to exit bootloader
b1	Command fail: version specified in header is older than current version
b2	Command fail: ED number specified in header doesn't match current ED
b3	Command fail: bad command checksum
b4	Command fail: timeout (<i>Unused</i>)
b5	Flash erase failed
b6	Bad hex record checksum
b7	Unrecognized hex record type
b8	Hex file receive timeout
b9	Hex programming error (<i>Gyrus Driver Only</i>)

- b. When the entire update file has been transmitted, the All Sport will show "FILE TRANSFERRED RETRY Y/N?" and the DakLoader2 program *Status* window will show "Field update complete. Waiting for retry or stop..."

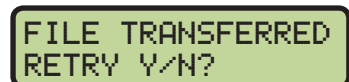

FILE TRANSFERRED
RETRY Y/N?

- If there are any supported drivers on the network that do not show the "bE" status code, press **<ENTER>** on the All Sport console to retry the update. Only those drivers that failed the first attempt will now receive the update.
- If all drivers updated successfully, press **<CLEAR>** on the All Sport console to return to normal operation. The console will indicate to the network that the update process is complete and all drivers will exit the bootload mode.

DO NOT UNPLUG OR POWER OFF THE ALL SPORT UNTIL IT HAS RETURNED TO NORMAL OPERATION!

This page intentionally left blank.

F Daktronics Warranty and Limitation of Liability

This section includes the Daktronics Warranty & Limitation of Liability statement (SL-02374).

This page intentionally left blank.

DAKTRONICS WARRANTY & LIMITATION OF LIABILITY

This Warranty and Limitation of Liability (the "Warranty") sets forth the warranty provided by Daktronics with respect to the Equipment. By accepting delivery of the Equipment, Purchaser and End User agree to be bound by and accept these terms and conditions. Unless otherwise defined herein, all terms within the Warranty shall have the same meaning and definition as provided elsewhere in the Agreement.

DAKTRONICS WILL ONLY BE OBLIGATED TO HONOR THE WARRANTY SET FORTH IN THESE TERMS AND CONDITIONS UPON RECEIPT OF FULL PAYMENT FOR THE EQUIPMENT

1. Warranty Coverage.

- A. Daktronics warrants to the original end user (the "End User", which may also be the Purchaser) that the Equipment will be free from Defects (as defined below) in materials and workmanship for a period of one (1) year (the "Warranty Period"). The Warranty Period shall commence on the earlier of: (i) four weeks from the date that the Equipment leaves Daktronics' facility; or (ii) Substantial Completion as defined herein. The Warranty Period shall expire on the first anniversary of the commencement date.

"Substantial Completion" means the operational availability of the Equipment to the End User in accordance with the Equipment's specifications, without regard to punch-list items, or other non-substantial items which do not affect the operation of the Equipment
- B. Daktronics' obligation under this Warranty is limited to, at Daktronics' option, replacing or repairing, any Equipment or part thereof that is found by Daktronics not to conform to the Equipment's specifications. Unless otherwise directed by Daktronics, any defective part or component shall be returned to Daktronics for repair or replacement. This Warranty does not include on-site labor charges to remove or install these components. Daktronics may, at its option, provide on-site warranty service. Daktronics shall have a reasonable period of time to make such replacements or repairs and all labor associated therewith shall be performed during regular working hours. Regular working hours are Monday through Friday between 8:00 a.m. and 5:00 p.m. at the location where labor is performed, excluding any holidays observed by Daktronics.
- C. Daktronics shall pay ground transportation charges for the return of any defective component of the Equipment. All such items shall be shipped by End User DDP Daktronics designated facility per Incoterms® 2020. If returned Equipment is repaired or replaced under the terms of this Warranty, Daktronics will prepay ground transportation charges back to End User and shall ship such items DDP End User's designated facility per Incoterms® 2020; otherwise, End User shall pay transportation charges to return the Equipment back to the End User and such Equipment shall be shipped Ex Works Daktronics designated facility per Incoterms® 2020. All returns must be pre-approved by Daktronics before shipment. Daktronics shall not be obligated to pay freight for any unapproved return. End User shall pay any upgraded or expedited transportation charges
- D. Any replacement parts or Equipment will be new or serviceably used, comparable in function and performance to the original part or Equipment and warranted for the remainder of the Warranty Period. Purchasing additional parts or Equipment from the Seller does not extend the Warranty Period.
- E. Defects shall be defined as follows. With regard to the Equipment (excepting LEDs), a "Defect" shall refer to a material variance from the design specifications that prohibit the Equipment from operating for its intended use. With respect to LEDs, "Defects" are defined as LED pixels that cease to emit light. Unless otherwise expressly provided, this Warranty does not impose any duty or liability upon Daktronics for partial LED pixel degradation. Notwithstanding the foregoing, in no event does this Warranty include LED pixel degradation caused by UV light. This Warranty does not provide for the replacement or installation of communication methods including but not limited to, wire, fiber optic cable, conduit, trenching, or for the purpose of overcoming local site interference radio equipment substitutions.

EXCEPT AS OTHERWISE EXPRESSLY SET FORTH IN THIS WARRANTY, TO THE MAXIMUM EXTENT PERMITTED BY APPLICABLE LAW, DAKTRONICS DISCLAIMS ANY AND ALL OTHER PROMISES, REPRESENTATIONS AND WARRANTIES APPLICABLE TO THE EQUIPMENT AND REPLACES ALL OTHER WARRANTIES OR CONDITIONS, EXPRESS OR IMPLIED, INCLUDING, BUT NOT LIMITED TO, ANY IMPLIED WARRANTIES OR CONDITIONS OF MERCHANTABILITY, FITNESS FOR A PARTICULAR PURPOSE, OR ACCURACY OR QUALITY OF DATA. OTHER ORAL OR WRITTEN INFORMATION OR ADVICE GIVEN BY DAKTRONICS, ITS AGENTS OR EMPLOYEES, SHALL NOT CREATE A WARRANTY OR IN ANY WAY INCREASE THE SCOPE OF THIS LIMITED WARRANTY.

THIS LIMITED WARRANTY IS NOT TRANSFERABLE.

2. Exclusion from Warranty Coverage

This Warranty does not impose any duty or liability upon Daktronics for any:

- A. damage occurring at any time, during shipment of Equipment unless otherwise provided for in the Agreement. When returning Equipment to Daktronics for repair or replacement, End User assumes all risk of loss or damage, agrees to use any shipping containers that might be provided by Daktronics, and to ship the Equipment in the manner prescribed by Daktronics;
- B. damage caused by: (i) the improper handling, installation, adjustment, use, repair, or service of the Equipment, or (ii) any physical damage which includes, but is not limited to, missing, broken, or cracked components resulting from non-electrical causes;



DAKTRONICS WARRANTY & LIMITATION OF LIABILITY

altered, scratched, or fractured electronic traces; missing or gauged solder pads; cuts or clipped wires; crushed, cracked, punctured, or bent circuit boards; or tampering with any electronic connections, provided that such damage is not caused by personnel of Daktronics or its authorized repair agents;

- C. damage caused by the failure to provide a continuously suitable environment, including, but not limited to: (i) neglect or misuse; (ii) improper power including, without limitation, a failure or sudden surge of electrical power; (iii) improper air conditioning, humidity control, or other environmental conditions outside of the Equipment's technical specifications such as extreme temperatures, corrosives and metallic pollutants; or (iv) any other cause other than ordinary use;
- D. damage caused by fire, flood, earthquake, water, wind, lightning or other natural disaster, strike, inability to obtain materials or utilities, war, terrorism, civil disturbance, or any other cause beyond Daktronics' reasonable control;
- E. failure to adjust, repair or replace any item of Equipment if it would be impractical for Daktronics personnel to do so because of connection of the Equipment by mechanical or electrical means to another device not supplied by Daktronics, or the existence of general environmental conditions at the site that pose a danger to Daktronics personnel;
- F. statements made about the product by any salesperson, dealer, distributor or agent, unless such statements are in a written document signed by an officer of Daktronics. Such statements as are not included in a signed writing do not constitute warranties, shall not be relied upon by End User and are not part of the contract of sale;
- G. damage arising from the use of Daktronics products in any application other than the commercial and industrial applications for which they are intended, unless, upon request, such use is specifically approved in writing by Daktronics;
- H. replenishment of spare parts. In the event the Equipment was purchased with a spare parts package, the parties acknowledge and agree that the spare parts package is designed to exhaust over the life of the Equipment, and as such, the replenishment of the spare parts package is not included in the scope of this Warranty;
- I. security or functionality of the End User's network or systems, or anti-virus software updates;
- J. performance of preventive maintenance;
- K. third-party systems and other ancillary equipment, including without limitation front-end video control systems, audio systems, video processors and players, HVAC equipment, batteries and LCD screens;
- L. incorporation of accessories, attachments, software or other devices not furnished by Daktronics; or
- M. paint or refinishing the Equipment or furnishing material for this purpose.

3. Limitation of Liability

- A. Daktronics shall be under no obligation to furnish continued service under this Warranty if alterations are made to the Equipment without the prior written approval of Daktronics.
- B. It is specifically agreed that the price of the Equipment is based upon the following limitation of liability. In no event shall Daktronics (including its subsidiaries, affiliates, officers, directors, employees, or agents) be liable for any claims asserting or based on (a) loss of use of the facility or equipment; lost business, revenues, or profits; loss of goodwill; failure or increased cost of operations; loss, damage or corruption of data; loss resulting from system or service failure, malfunction, incompatibility, or breaches in system security; or (b) any special, consequential, incidental or exemplary damages arising out of or in any way connected with the Equipment or otherwise, including but not limited to damages for lost profits, cost of substitute or replacement equipment, down time, injury to property or any damages or sums paid to third parties, even if Daktronics has been advised of the possibility of such damages. The foregoing limitation of liability shall apply whether any claim is based upon principles of contract, tort or statutory duty, principles of indemnity or contribution, or otherwise
- C. In no event shall Daktronics be liable for loss, damage, or injury of any kind or nature arising out of or in connection with this Warranty in excess of the Purchase Price of the Equipment. The End User's remedy in any dispute under this Warranty shall be ultimately limited to the Purchase Price of the Equipment to the extent the Purchase Price has been paid.

4. Assignment of Rights

- A. The Warranty contained herein extends only to the End User (which may be the Purchaser) of the Equipment and no attempt to extend the Warranty to any subsequent user-transferee of the Equipment shall be valid or enforceable without the express written consent of Daktronics.

5. Governing Law; Election of Remedies

- A. The rights and obligations of the parties under this Warranty shall not be governed by the provisions of the United Nations Convention on Contracts for the International Sales of Goods of 1980. The parties consent to the application of the laws of the State of South Dakota to govern, interpret, and enforce each of the parties' rights, duties, and obligations arising from, or relating in any manner to, the subject matter of this Warranty, without regard to conflict of law principles.
- B. Any dispute, controversy or claim arising from or related to this Warranty, the parties shall first attempt to settle through negotiations. In the event that no resolution is reached, then such dispute, controversy, or claim shall be resolved by final and binding arbitration under the Rules of Arbitration of the International Chamber of Commerce. The language of the arbitration

DAKTRONICS WARRANTY & LIMITATION OF LIABILITY

shall be English. The place of the arbitration shall be Sioux Falls, SD. A single arbitrator selected by the parties shall preside over the proceeding. If a single arbitrator cannot be agreed upon by the parties, each party shall select an arbitrator, and those arbitrators shall confer and agree on the appointed arbitrator to adjudicate the arbitration. The arbitrator shall have the power to grant any provisional or final remedy or relief that it deems appropriate, including conservatory measures and an award of attorneys' fees. The arbitrator shall make its decisions in accordance with applicable law. By agreeing to arbitration, the Parties do not intend to deprive any court of its jurisdiction to issue a pre-arbitral injunction, pre-arbitral attachment, or other order in aid of arbitration proceedings and the enforcement of any award. Without prejudice to such provisional remedies as may be available under the jurisdiction of a court, the arbitrator shall have full authority to grant provisional remedies and to direct the Parties to request that any court modify or vacate any temporary or preliminary relief issued by such court, and to award damages for the failure of any Party to respect the arbitrator's orders to that effect.

6. Availability of Extended Service Agreement

- A. For End User's protection, in addition to that afforded by the warranties set forth herein, End User may purchase extended warranty services to cover the Equipment. The Extended Service Agreement, available from Daktronics, provides for electronic parts repair and/or on-site labor for an extended period from the date of expiration of this warranty. Alternatively, an Extended Service Agreement may be purchased in conjunction with this Warranty for extended additional services. For further information, contact Daktronics Customer Service at 1-800-DAKTRONics (1-800-325-8766).

Additional Terms applicable to sales outside of the United States

The following additional terms apply **only** where the installation site of the Equipment is located outside of the United States of America.

1. In the event that the installation site of the Equipment is in a country other than the U.S.A., then, notwithstanding Section 5 of the Warranty, where the selling entity is the entity listed in Column 1, then the governing law of this Warranty is the law of the jurisdiction listed in the corresponding row in Column 2 without regard to its conflict of law principles. Furthermore, if the selling entity is an entity listed in Column 1, then the place of arbitration is listed in the corresponding row in Column 3.

Column 1 (Selling Entity)	Column 2 (Governing Law)	Column 3 (Location of Arbitration)
Daktronics, Inc.	The state of Illinois	Chicago, IL, U.S.A.
Daktronics Canada, Inc.	The Province of Ontario, Canada	Toronto, Ontario, Canada
Daktronics UK Ltd.	England and Wales	Bristol, UK
Daktronics GmbH	The Federal Republic of Germany	Wiesbaden, Germany
Daktronics Hong Kong Limited	Hong Kong, Special Administrative Region of the P.R.C.	Hong Kong SAR
Daktronics Shanghai Co., Ltd.	The Peoples Republic of China	Shanghai, P.R.C.
Daktronics France, SARL	France	Paris, France
Daktronics Japan, Inc.	Japan	Tokyo, Japan
Daktronics International Limited	Macau, Special Administrative Region of the P.R.C.	Macau SAR
Daktronics Australia Pad Ltd	Australia	Sydney, Australia
Daktronics Singapore Pte. Ltd	Singapore	Singapore
Daktronics Brazil LTDA	Brazil	São Paulo, Brazil
Daktronics Spain S.L.U.	Spain	Madrid, Spain
Daktronics Belgium N. V	Belgium	Kruikeke, Belgium
Daktronics Ireland Co. Ltd.	Ireland	Dublin, Ireland

This page intentionally left blank.